

Alfred Härtl

Halbleiter

Anschluß-Tabelle

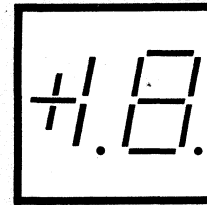
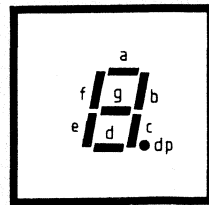
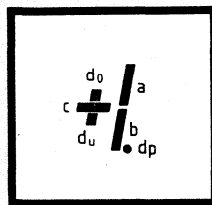
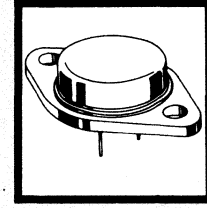
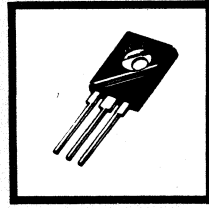
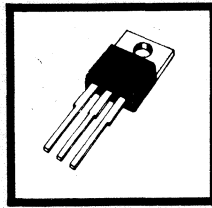
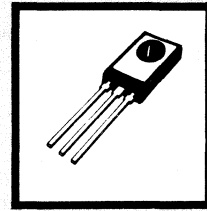
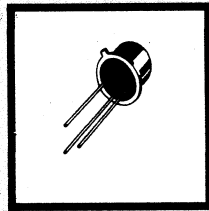
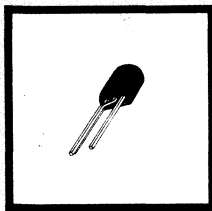
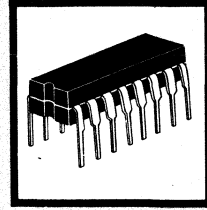
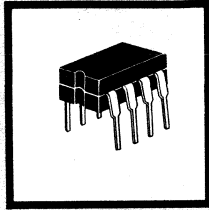
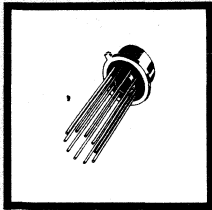

700 Anschlußbelegungen der wichtigsten TTL-ICs,
C-MOS ICs, Linear ICs, Transistoren
und Sieben-Segment-Anzeigen.

Alfred Härtl

Halbleiter

Anschluß-Tabelle

Härtl, Alfred
Halbleiter-Anschluß-Tabelle
Anschlußbelegungen der wichtigsten
TTL-ICs, C-MOS-ICs, Linear-ICs,
Transistoren und Sieben-
segment-Anzeigen
ISBN 3-9800 725-1-7

2., überarbeitete und erweiterte Auflage

Alle in diesem Buch veröffentlichten Schaltungen und Verfahren werden ohne Rücksicht auf die Patentlage oder mögliche Schutzrechte Dritter mitgeteilt. Sie sind ausschließlich für Lehrzwecke bestimmt.

Autor und Verlag haben alle Sorgfalt walten lassen, um Fehler nach Möglichkeit auszuschließen. Die angegebenen Daten dienen allein der Produktbeschreibung und sind nicht als zugesicherte Eigenschaften im Rechtssinne aufzufassen. Es wird keine Verantwortung oder Haftung für Folgen, die auf fehlerhafte Angaben zurückzuführen sind, übernommen. Für die Mitteilung eventueller Fehler sowie für Ergänzungs- und Verbesserungsvorschläge ist der Verlag jederzeit dankbar.

ISBN 3-9800725-1-7
© 1985 by Härtl-Verlag

Druck: W. Tümmels Buchdruckerei und Verlag GmbH, Nürnberg
Umschlaggestaltung: A. Härtl

Vorwort

Die Typenvielfalt von Halbleiter-Bauelementen (z. B. TTL-CMOS-Linear ICs, Transistoren oder Siebensegmentanzeigen) schafft für den Praktiker oft Probleme, da meist keine Anschlußbelegungen der genannten Bauteile zur Verfügung stehen.

In der vorliegenden Broschüre wurde dieser Problematik Rechnung getragen.

Es wurden die wichtigsten Bauelemente – teilweise mit ihren Ersatztypen – und Anschlußbelegungen zusammengestellt. Natürlich kann und soll diese Broschüre nicht die „großen“ Datenbücher der Hersteller ersetzen. Der Zweck dieser Publikation ist, Sie schnell über Schaltkreise und Anschlußbelegungen von Bauelementen der verschiedensten Hersteller zu informieren.

Durch die Gliederung in alphabetischer Reihenfolge wird Ihnen das Auffinden bevorstehender Typen erleichtert.

Der Verfasser

Inhaltsverzeichnis

Vorwort	3
TTL-ICs	9 – 20
C-MOS-ICs	21 – 30
Transistoren/Thyristoren/Triacs, MOS-Feldeffekt-Transistoren	31 – 42
Siebensegmentanzeigen, 3½-stellige LCD-Anzeige	43 – 57
Linear-ICs	58 – 79
Quellennachweis	80

Typenbezeichnung (Linear)	Seite	Bild
A 208 D = TBA 810 AS	58	1/56
CA 081 = TL 081	58	2
CA 082 = TL 082	58	3
CA 084 = TL 084	65	65
CA 111	60	23/24
CA 139, A	65	68
CA 211	60	23/24
CA 239, A	65	68
CA 311	60	23/24
CA 324 = LM 324 = TDB 0124	58	4
CA 339, A	65	68
CA 555 = NE 555	58	5
CA 723 = LM 723 = MC 1723 = SFC 2723	61	33/35
CA 741 = LM 741 TO	58	6
CA 741 = LM 741 Dip 8/Dip 14	58	7/7a
CA 747 = LM 747	58	8/10
CA 748 = LM 748	58	9/11
CA 1458 = MC 1458	59	12/13
CA 2002 = TDA 2002	65	76
CA 3026	79	184
CA 3046 = CA 3086 = SFC 2046	59	14
CA 3048	79	186
CA 3049	79	184
CA 3052	79	186
CA 3054	79	185
CA 3060 A, B		
CA 3085 E	68	90
CA 3086	59	14
CA 3160	68	91/92
CA 3161	68	93
CA 3162	68	94
CA 3240 (Anschlußgleich mit CA 747)	58	8/10
CA 2447 = LM 747 = SFC 2747 = CA 747	58	8/10
CA 2458 = MC 1458	59	12/13
ICL 7106	68	95
ICL 7107	68	95
ICL 7126	70	107
ICL 8038 = XR 8038	65	64
ICM 7038	70	106

Typenbezeichnung (Linear)	Seite	Bild
ICM 7555 C-MOS 555 (Anschlußgleich mit NE 555)	58	5
L 123 = LM 723 = CA 723 = SFC 2723	61	33/35
L 129/5 = TDA 1405	60	29
L 130/12 = TDA 1412	60	29
L 131/15 = TDA 1415	60	29
L 146 = TDB 1146	59	15/16
L 200 = TDB 0200	59	17
L 201 = XR 2201 = ULN 2001 = MC 1411	63	47
L 202 = XR 2202 = ULN 2002 = MC 1412	63	47
L 203 = XR 2203 = ULN 2003 = MC 1413	63	47
LF 198, F, N, H	74	140/144
LF 298 F, N, H	74	140/144
LF 355 = TDB 0155	59	18/19
LF 356 = TDB 0156 = TL 081	59	18/19
LF 357 = TDB 0157	59	18/19
LF 358 = TDB 0158	62	45/46
LF 398 F, N, H	74	140/144
LM 78 XX = μ A 78 XX = 78 XX	73	133
LM 79 XX = μ A 79 XX = 79 XX	79	190
LM 111	53	23/24
LM 139	65	68
LM 139 F, N	65	68
LM 185 H-1.2	78	183
LM 193 N, FE	75	146
LM 211	53	23/24
LM 239	64	68
LM 239 F, N	65	68
LM 285 H-1.2	78	183
LM 293 N, FE	75	146
LM 309 K = SFC 2309	60	22
LM 311 = SFC 2311	60	23/24
LM 317 LP = Geh. TO 92	60	25
LM 317 K = TDB 0117 KF Geh. TO 3	60	26
LM 317 T = TDB 0117 SP Geh. TO 220	60	26
LM 320 L, ML Spannungsregler	78	179/180
LM 323 K = TDB 0123 = 7805 KC	60	27
LM 324 = TDB 0124 = CA 324 = TDB 0324	60	28
LM 330 T-positiv Regler	78	181

Typenbezeichnung (Linear)	Seite	Bild
LM 334 Z = TDB 0134	64	63
LM 337 L	60	25
LM 339	64	68
LM 340 K-5 = μ A 7805 KC (bis 7824)	73	133
LM 380 N	68	96
LM 380 N 8	69	97
LM 383 = TDA 2002	66	76
LM 385 H-1.2	78	183
LM 385 Z-1.2	78	182
LM 386	69	98
LM 387	69	99
LM 389	69	100
LM 390	69	101
LM 393 N, FE	75	146
LM 555 = CA 555 = NE 555 = SN 72555	58	5
LM 567 = XR 567 = NE 567	67	81
LM 703 = SN 76603	62	40
LM 709 = SFC 2709	61	30/31/32
LM 711 = μ A 711	79	191
LM 723 = MC 1723 = TDB 0723 = SFC 2723	61	33/35
LM 739 = TBA 231 = RC 4739 = XR 4739	61	36
LM 741 = MC 1741 = TBA 221 A/E = SFC 2741	61	37/38/39
LM 747 = CA 747 = TDB 0747 = SFC 2747 = TDA 2747	58	8/10
LM 748 = MC 1748 = CA 748	58	9/11
LM 1310 = MC 1310 = XR 1310	62	44
LM 1458 = MC 1458 = SFC 2458	59	12/13
LM 1900	70	108
LM 2900	70	108
LM 2901 F, N	65	68
LM 2903 N, FE	75	146
LM 3046 = CA 3046	59	14
LM 3900	70	108
LM 3911	67	84a
LM 5000 = NE 555 = CA 555	58	5
LM 13600 = LM 13700	66	75
LS 141 = LM 741 = CA 741 = SFC 2741	61	37/38/39
LS 7220	65	69
LAS 15 XX = 78 XX	73	133
M 78 L 05 = μ A 78 L 05	79	189
MC 78 L XX = μ A 78 L XX	79	189
MC 78 M XX = 78 M XX	74	137
MC 79 L XX = 79 L XX	76	164
MC 1310 P = XR 1310 = LM 1310	62	44

Typenbezeichnung (Linear)	Seite	Bild
MC 1412 = L 202 = ULN 2002	63	47
MC 1413 = L 203 = ULN 2003	63	47
MC 1458 = LM 1458 = SFC 2458 = XR 1458	59	12/13
MC 1488 = SN 75188		
MC 1488 F, N	77	165
MC 1489 F, AF, N, AN	77	166
MC 1555 = NE 555 = CA 555 = SN 72555	58	5
MC 1709 = LM 709 =	61	30/31/32
MC 1723 = LM 723 = μ A 723	61	33/35
MC 1741 = LM 741 = μ A 741 = CA 741 = LS 141	58	7/7a
MC 1748 = LM 748	58	9/11
MC 3302	65	68
MC 3303	63	48
MC 3403	63	48
MC 3456 = LM 556 = NE 556 = TDB 0556	63	49
MC 4558 = TDB 4558 = μ A 4558	66	73/74
MC 7805 CK = μ A 7805 KC (bis 7824)	73	133
MC 7805 CP = μ A 7805 UC (bis 7824)	73	133
MC 7905 CP = μ A 7905 UC (bis 7924)	79	190
MC 34001 = TL 081	58	2
MK 50250	70	111
MLM 311 = LM 311	60	23/24
MLM 324 = LM 324 = CA 324 = μ A 324	58	4
MM 5314	65	70
MM 5837	70	110
NE 521 D, F, N	75	147
NE 522 D, F, N	75	147
NE 527 D, N, F	75	148
NE 529 D, N, F	75	148
NE 530 FE, N, H	75	149
NE 538 N, FE, H	75	149
NE 544	66	72
NE 555 = TDB 0555 = CA 555 = SN 72555	58	5
NE 556 = MC 3456 = XR 556 = TDB 0556	63	49
NE 564	78	174
NE 565 F, N, D	78	175/176
NE 567 = XR 567 = LM 567	67	81
NE 587 F, N	76	161
NE 589 F, N	76	162
NE 592 DE, FE N 8	76	159
NE 592 DH, N 14, H	76	157/158

Typenbezeichnung (Linear)	Seite	Bild
NE 594, SA 594 N, F	76	163
NE 644	70	105
NE 5044 D, N	77	171
NE 5045 N, D	77	172
NE 5514 F, N, D	75	150
NE 5517 N, D, AN	75	151
NE 5532 FE, AFE, N	75	152
NE 5533 M	76	154
NE 5534 N, FE, D	75	153
NE 5535 N, H	76	155/156
NE 5539 F, N, D	76	160
NE 5553 F, N	77	167
NE 5553 H	77	169
NE 5553 U	77	168
RC 723 = LM 723 = CA 723	61	33/35
RC 1458 = MC 1458 = LM 1458	59	12/13
RC 4136	66	77
RC 4739 = LM 739 = TBA 231	61	36
S 576 A, B, C, D	67	85
SE 521 D, F, N	75	147
SE 522 D, F, N	75	147
SE 527 D, N, F	75	148
SE 529 D, N, F	75	148
SE 530 FE, N, H	75	149
SE 538 N, FE, H	75	149
SE 555 = NE 555 = CA 555 = LM 555	58	5
SG 78 XX = 76 XX	73	133
SG 723 = CA 723 = LM 723	61	33/35
SG 3524	77	170
SN 28 654 N	71	113
SN 29776 P = SAK 215	69	102
SN 72555 = NE 555 = CA 555 = LM 555	58	5
SN 72558 = MC 1458 = LM 1458	59	12/13
SN 75188 = MC 1488		
SN 76603 = LM 703	62	40
SAB 0529	74	141
SAB 0600 Dreiklang-Gong	65	66
SAB 0601 Einton-Gong	65	66
SAB 0602 Zweiton-Gong	65	66
SAE 0700 Signalton-Generator	70	112
SAJ 141	67	84
SAJ 300 T	62	41
SAK 215 = SN 29767 P	69	102
SAS 241	67	86
SAS 261	75	145
SFC 2046 = CA 3046	59	14

Typenbezeichnung (Linear)	Seite	Bild
SFC 2101	60	20/21
SFC 2301 = LM 301	60	20/21
SFC 2458 - MC 1458 = TDB 1458	59	12/13
SFC 2723 = LM 723 = CA 723 = L 123	61	33/35
SFC 2741 = LM 741 = MC 1741	61	37/38/39
SFC 2747 = LM 747 = TDB 0747	58	8/10
SFC 2748 = LM 748 = TDB 0748	58	9/11
SFC 2861 = TAA 861 A	63	50/52
TL 082	58	3
TL 084 = XR 084	64	65
TL 317 LP = LM 317 LP	60	25
TL 604	70	109
TL 780 XX = 78 XX	73	133
TL 3741 = LM 741 = CA 741 = LS 141	61	37/38/39
TAA 521 = LM 709 = MC 1709	61	30/31/32
TAA 761 = TAA 762; A	72	127
TAA 762, 762 A	71	115/116
TAA 765 = TAA 762; A	72	127/128
TAA 765 A	71	116
TAA 861	73	129
TAA 861 A = TAA 765 A	63	50/52
TAA 862	73	129
TAA 865 = TAA 762	73	129
TAA 865 A	63	50
TAA 2761 = TAA 2762	63	53/54
TAA 2762	71	117
TAA 2762 A	71	118
TAA 2765 A	71	118
TAA 4761 = TAA 4765 A	64	55
TAA 4762 A	71	114
TAA 4765 A	71	114
TAB 1453 = TAE 1453 A	71	119
TAB 4453 A = TAE 4453 A	72	126
TAE 1453 A	71	119
TAE 2453	72	121
TAE 4453	71	120
TAF 1453 A	71	119
TAF 2453 A	72	121
TAF 4453 A	71	120
TBA 221 B = LM 741 = CA 741 = SFC 2741	61	37/38/39
TBA 221 B, 222 B	72	124
TBA 222	72	125
TBA 231 = LM 739	61	36
TBA 331 = CA 3046 = SFC 2046	59	14
TBA 810 S, AS, DS	64	56/1

Typenbezeichnung (Linear)	Seite	Bild
TBB 0324 = LM 324 = CA 324	60	28
TBB 1331 A	65	67
TBB 1458 = MC 1458 = CA 1458	59	12/13
TBB 2331 B = TBE 2335 B	67	83
TBB 4331, TBE 4335 A	73	130
TBC 2332 B	67	83
TBC 4332 A	72	122
TBE 2335 B	67	83
TBE 4335 A	72	122
TCA 105	61	34
TCA 205 A	74	142
TCA 311 A = TCA 315 A	64	57/58
TCA 312 A = TCA 325 A	64	57/58
TCA 315 A	64	57/58
TCA 321, 321 A	73	131/132
TCA 321 = TCA 322	73	131
TCA 322	73	131
TCA 322 A	63	58
TCA 325, 325 A	73	131/132
TCA 325 A	63	58
TCA 331 A = TCA 335 A	64	59/60
TCA 332	64	59/60
TCA 335	64	59/60
TCA 345 A	64	61
TCA 365	67	87
TCA 671	59	14
TCA 871	59	14
TCA 965	65	71
TCA 971	59	14
TCA 2365	72	123
TDA 0200 = L 200	59	17
TDA 1405 = L 129	60	29
TDA 1412 = L 130	60	29
TDA 1415 = L 131	60	29
TDA 2002 = LM 383	66	76
TDA 2747 = LM 747 = TDB 0747	58	8/10
TDA 2748 = LM 748 = MC 1748	58	9/11
TDB 16 XX = 78 M XX	74	137
TDB 0062 DP = TL 062 CP	58	3
TDB 0064 = 4fach-OP m. J-FET Eing.	58	4
TDB 0064 DP = TL 064 CN	65	65
TDB 0071 = TL 071	58	2
TDB 0071 DP = TL 071 CP	58	2
TDB 0072 DP = TL 072 CP	58	3
TDB 0074 DI = TL 074	65	65
TDB 0081 = TL 081 DP	58	2
TDB 0082 = TL 082 CP	58	3

Typenbezeichnung (Linear)	Seite	Bild
TDB 0084 = TL 084 CN	65	65
TDB 0117 = LM 317	60	25/26
TDB 0123 = LM 323 K	60	27
TDB 0124 = LM 324 = CA 324	58	4
TDB 0146	58	88
TDB 0155 = LF 355	59	18/19
TDB 0156 = LF 356	59	18/19
TDB 0157 = LF 357	59	18/19
TDB 0158 = LF 358	62	45/46
TDB 0200 = L 200	59	17
TDB 0555 = NE 555 = CA 555 = LM 555	58	5
TDB 0556 = NE 556 = LM 556	63	49
TDB 0723 = LM 723 = MC 1723	61	33/35
TDB 0747 = LM 747	58	8/10
TDB 1146 = L 146	59	15/16
TDB 2331	67	82/83
TDB 2332	67	82/83
TDB 2335	67	82/83
TDB 3403 = MC 3403 = XR 3403	63	48
TDB 4558 = MC 4558 = TDC 4558	66	73/74
TDC 0155/156/157	59	18/19
TDC 4558	66	73/74
TDE 0155/156/157	59	18/19
TL 060	58	2
TL 061	58	2
TL 062	58	3
TL 071	58	2
TL 072	58	3
TL 074	65	65
TL 080	69	103
TL 081 = MC 34001	58	2
TL 082	58	3
TL 084 = XR 084	65	65
TL 317 LP = LM 317 LP	60	25
TL 604	70	109
TL 3741 = LM 741 = CA 741 = LS 741	61	37/38/39
TTB 78 XX T	73	133
TTB 78 XX TO-3	73	134
U 237	63	51
U 257	63	51
UAA 3000	69	104
ULN 2001 = L 201 = XR 2201	63	47
ULN 2002 = L 202 = XR 2202 = LP 1233	63	47
ULN 2003 = L 203 = XR 2203	63	47
XR 084 = TL 084	65	65

Typenbezeichnung (Linear)	Seite	Bild
XR 567 = NE 567 = LM 567	67	81
XR 1310 = MC 1310	62	44
XR 1458 = MC 1458	59	12/13
XR 2202 = ULN 2002	63	47
XR 2203 = ULN 2003	63	47
XR 2206	66	80
XR 2240	66	78
XR 2242	66	79
XR 2264	68	89
XR 2265	68	89
XR 4136 = RC 4136	66	77
XR 4741	64	62
XR 8038 = ICL 8038	65	64
XRL 555 CP = ICM C-MOS-Version	58	5
μ A 301 = LM 301 = CA 301 = SFC 2301	60	20/21
μ A 324 = LM 324 = TDB 0124	60	28
μ A 1458 = MC 1458 = RC 1458 = LM 1458 = SFC 2458	59	12/13
μ A 555 = NE 555 = CA 555 = TDB 0555	58	5
μ A 556 = MC 3456 = LM 556 = RC 556 = TDB 0556 = NE 556	63	49
μ A 709 = MC 1709 = LM 709 = TAA 521	61	30/31/32
μ A 723 = MC 1723 = LM 723 = CA 723 = RC 723 = TDB 0723	61	33/35

Typenbezeichnung (Linear)	Seite	Bild
μ A 741 = MC 1741 = LM 741 = RC 741 = TBA 221 = SFC 2741	61	37/38/39
μ A 747 = LM 747 = MC 1447 = RC 747 = CA 747 = TDB 0747 = SFC 2747	58	8/10
μ Pc 151 = CA 741 = LM 741 = MC 1741	61	37/38/39
μ Pc 251 = CA 747 = LM 747 = MC 1747	58	8/10
μ Pc 301 = LM 301	60	20/21
μ Pc 324 = LM 324 = CA 324 = TDB 0124	60	28
μ A 7805 . . .	73	133
μ A 79 GKC	74	138
μ A 78 XX	73	133
μ A 79 GU 1 C	74	139
78 HGKC	79	188
78 HXX KC	73	134
78 P 05 5V 10 A	73	134
79 MXX	73	135/136
566 H	77	173
566 N, D, F	78	177/178
7805 - 7824 = μ A 7805 bis 24	73	133
78 SXX	73	133
78 M 05 - 78 M 24 = μ A 78 M 05 (bis 78 24 V)	74	137

Anschlußbelegungen von TTL-ICs

SN 7400

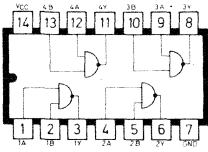

Vier NAND-Gatter mit je 2 Eing.

SN 7405

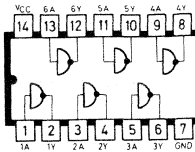

Sechs Inverter (o. K.)

SN 7410

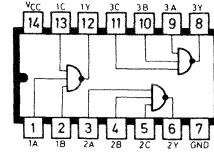

Drei NAND-Gatter mit je 3 Eing.

SN 7401

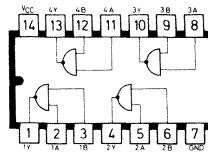

Vier NAND-Gatter mit je 2 Eingängen (o.K.)

SN 7406

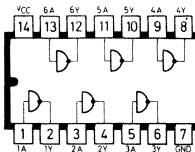

Sechs invertierende Treiber (o. K. 30 V)

SN 74 LS 11

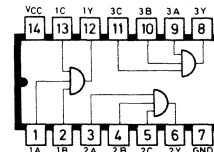

Drei AND-Gatter mit je 3 Eing.

SN 7402

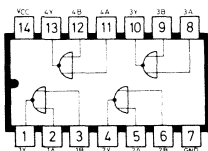

Vier NOR-Gatter mit je 2 Eing.

SN 7407

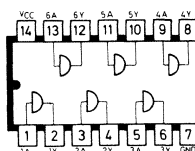

Sechs Treiber (o. K. 30 V)

SN 7412

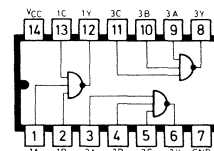

Drei NAND-Gatter mit je 3 Eingängen (o. K.)

SN 7403

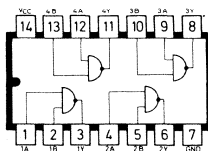

Vier NAND-Gatter mit je 2 Eingängen (o. K.)

SN 7408

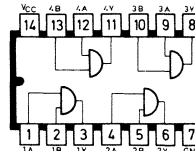

Vier AND-Gatter mit je 2 Eing.

SN 7413

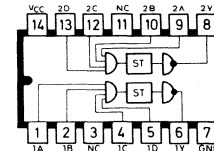

Zwei NAND-Schmitt-Trigger mit je 4 Eingängen

SN 7404

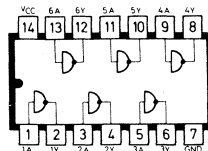

Sechs Inverter

SN 7409

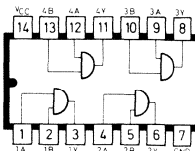

Vier AND-Gatter mit je 2 Eingängen (o. K.)

SN 7414

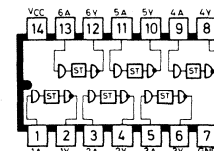

Sechs invertierende Schmitt-Trigger

Anschlußbelegungen von TTL-ICs

SN 74 LS 15

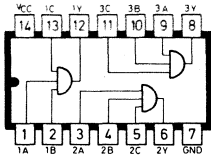

Drei AND-Gatter mit je 3 Eingängen (o. K.)

SN 7422

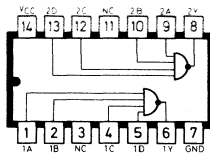

Zwei NAND-Gatter mit je 4 Eing.

SN 7428

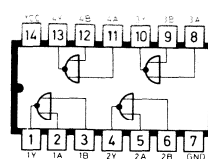

Vier NOR-Leistg.-Gatter mit je 2 Eingängen

SN 7416

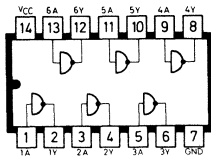

Sechs invertierende Treiber (o. K.)

SN 7423

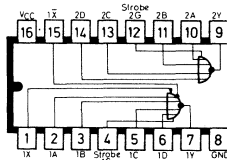

Zwei NOR-Gatter mit je 4 Eing.

SN 7430

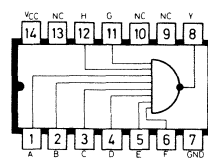

NAND-Gatter mit 8 Eingängen

SN 7417

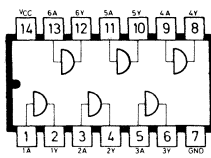

Sechs Treiber (o. K., 15 V)

SN 7425

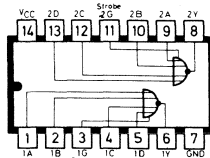

Zwei NOR-Gatter mit je 4 Eing.

SN 7432

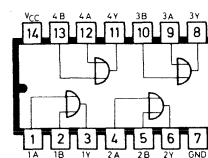

Vier OR-Gatter mit je 2 Eingängen

SN 7420

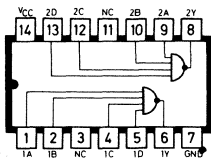

Zwei NAND-Gatter mit je 4 Eing.

SN 7426

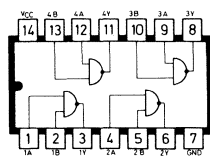

Vier NAND-Gatter mit je 2 Eing.

SN 7433

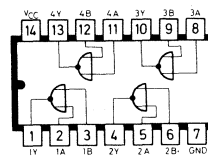

Vier NOR-Leistg.-Gatter mit je 2 Eingängen

SN 74 LS 21

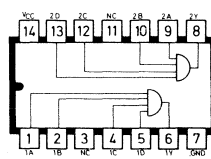

Zwei AND-Gatter mit je 4 Eing.

SN 7427

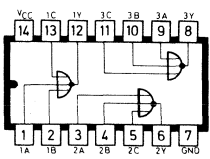

Drei NOR-Gatter mit je 3 Eing.

SN 7437

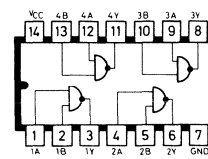

Vier NAND-Leistg.-Gatter mit je 2 Eingängen

Anschlußbelegungen von TTL-ICs

SN 7438

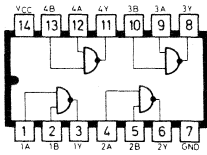

Vier NAND-Leistg.-Gatter mit je 2 Eingängen

SN 7445

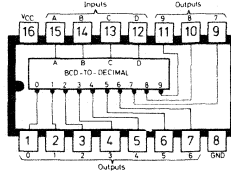

BCD zu Dezimal-Dekoder/
Anzeigentreiber

SN 7450

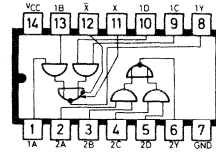

Zwei AND/OR/INVERT-Gatter

SN 7440

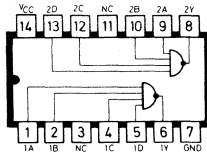

Zwei NAND-Leistg.-Gatter mit je 4 Eingängen

SN 7446

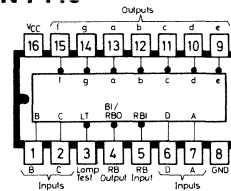

BCD zu 7-Segment-Dekoder/
Anzeigentreiber

SN 7451

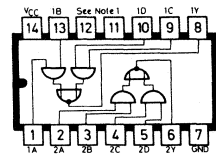

Zwei AND/OR/INVERT-Gatter

SN 7442

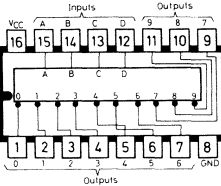

BCD zu Dezimal-Dekoder

SN 7447

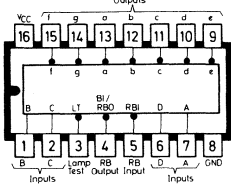

BCD zu 7-Segment-Dekoder/
Anzeigentreiber

SN 7453

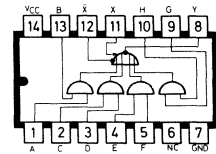

Exp. AND/OR/INVERT-Gatter

SN 7443

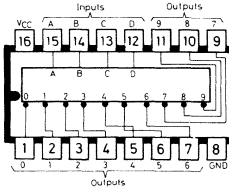

Excess-3 zu Dezimal-Dekoder

SN 7448

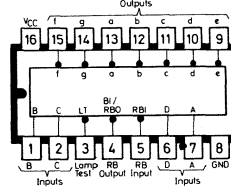

BCD zu 7-Segment-Dekoder/
Anzeigentreiber

SN 7454

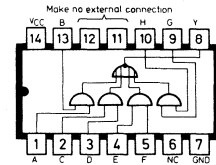

AND/OR/INVERT-Gatter

SN 7444

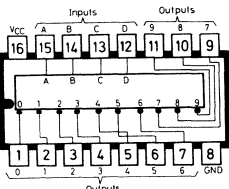

Excess-3-Gray zu Dezimal-Dekoder

SN 74 LS 49

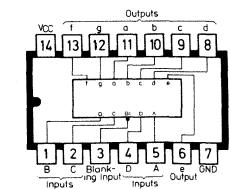

BCD zu 7-Segment-Dekoder/
Anzeigentreiber

SN 74 LS 55

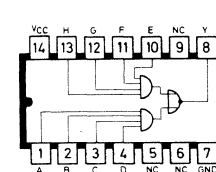

AND/OR/INVERT-Gatter
m. 2 x 4 Eingängen

Anschlüsselegungen von TTL-ICs

SN 7460

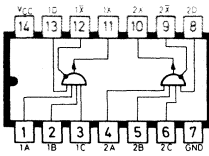

Zwei Exp. mit je 4 Eingängen

SN 74 LS 63

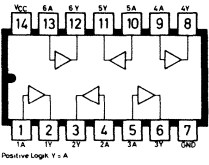

Sechs Stromsensoren

SN 7470

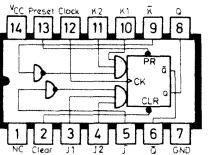

J-K-Flipflop mit je 3 Eingängen

SN 7472

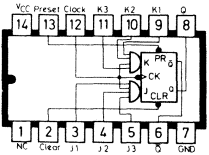

J-K-Master-Slave-Flipflop

SN 7473

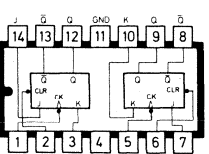

Zwei JK-Flipflops mit Clear

SN 7474

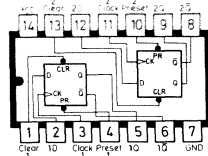

Zwei D-Flipflops mit Preset und Clear

SN 7475

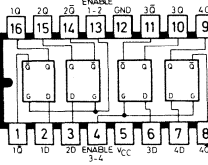

Zwei 2-Bit-D-Latches mit Enable

SN 7476

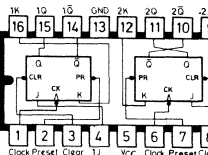

Zwei J-K Flipflops mit Preset und Clear

SN 7480

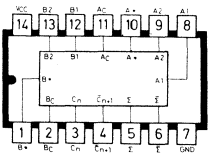

1-Bit Volladdierer

SN 7481

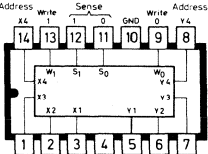

16-Bit-Schreibe-Lese-Speicher

SN 7482

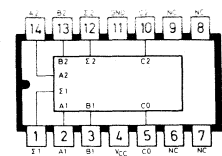

2-Bit-Volladdierer

SN 7483

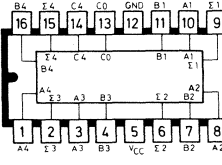

4-Bit-Volladdierer

SN 7484

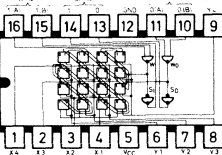

16-Bit-Schreibe-Lese-Speicher

SN 7485

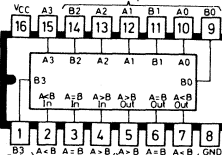

4-Bit-Vergleicher

SN 7486

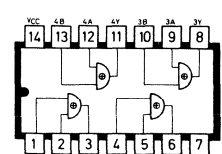

Vier EXCLUSIVE-OR-Gatter

Anschlußbelegungen von TTL-ICs

SN 7490

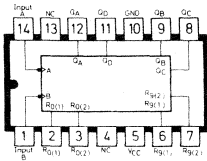

Dezimalzähler

SN 7495

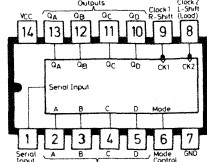

4-Bit-Schieberegister

SN 74105

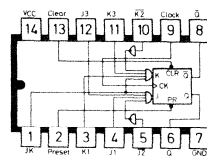

J-K-Master-Slave-Flipflop

SN 7491

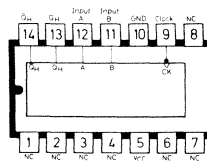

8-Bit-Schieberegister

SN 7496

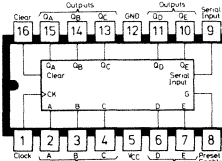

5-Bit-Schieberegister

SN 74107

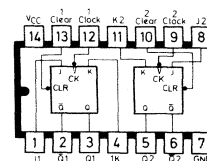

Zwei J-K-Flipflops mit Clear

SN 7492

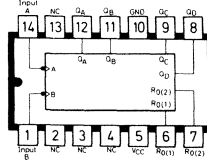

Zähler bis 12

SN 7497

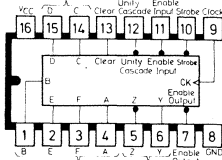

Synchr. programmierbarer
6-Bit-Bin. Teiler

SN 74109

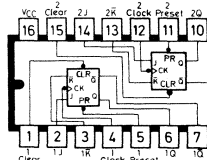

Zwei J-K-Flipflops mit Preset
und Clear

SN 7493

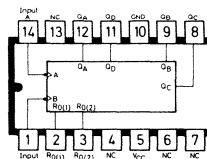

4-Bit-Binärzähler

SN 74100

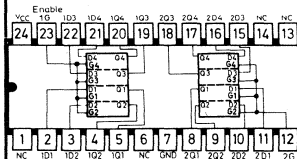

Zwei 4-Bit-Latches mit Enable

SN 74110

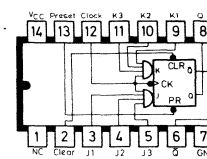

J-K-Master-Slave-Flipflop

SN 7494

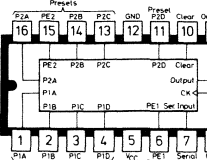

4-Bit-Schieberegister

SN 74104

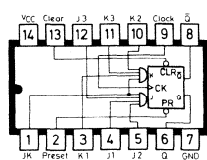

J-K-Master-Slave-Flipflop

SN 74111

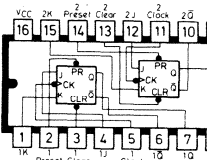

Zwei J-K-Master-Slave-Flipflops

Anschlußbelegungen von TTL-ICs

SN 74115

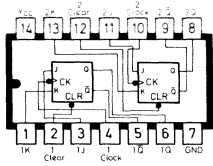

Zwei J-K-Master-Slave-Flipflops

SN 74116

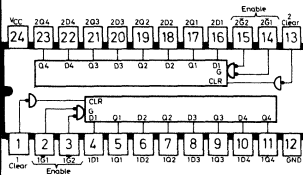

Zwei 4-Bit-D-Latches

SN 74118

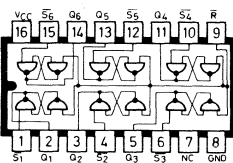

Sechs R-S-Latches mit gem. Reset

SN 74119

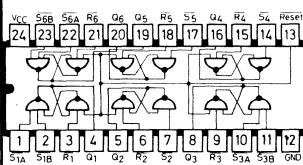

Sechs R-S-Latches mit zus. Reset

SN 74120

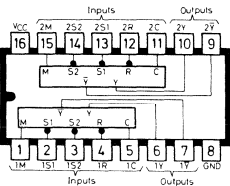

Zwei Pulssynchronisierer/Treiber

SN 74121

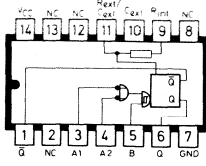

Monoflop mit Schmitt-Trigger-Eingang

SN 74122

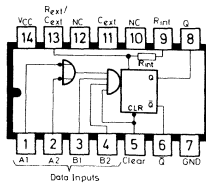

Retriggerbares Monoflop mit Clear

SN 74123

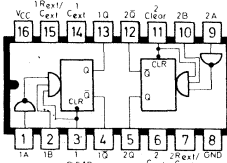

Zwei retriggerbare Monoflops mit Clear

SN 74125

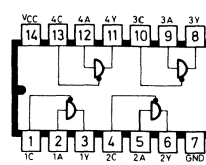

Vier Bus-Leistungstreiber

SN 74126

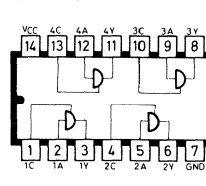

Vier Bus-Leistungstreiber

SN 74128

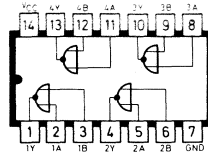

Vier 50 Ω-NOR-Leistungstreiber

SN 74132

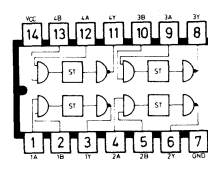

Vier NAND-Schmitt-Trigger

SN 74136

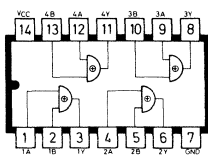

Vier EXCLUSIVE-Gatter

SN 74137

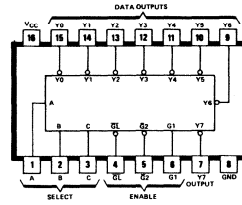

3-Bit-Dekoder/Demultiplexer

SN 74 LS 138

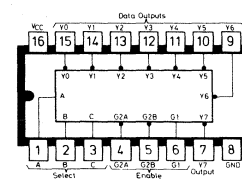

3-Bit-Binärdekoder/Demultiplexer

Anschlußbelegungen von TTL-ICs

SN 74141

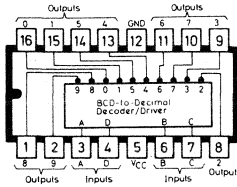

BCD zu Dezimal-Dekoder
Anzeigentreiber

SN 74147

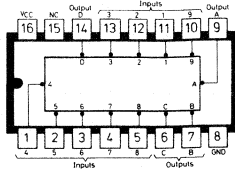

Dezimal zu BCD Prioritätsentk.

SN 74154

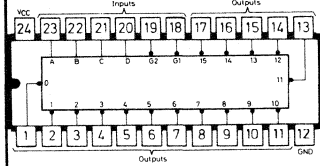

4-Bit Binärdekoder / Demultipl.

SN 74142

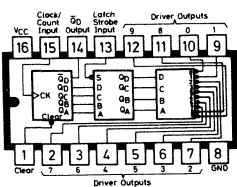

Dezimal, 4-Bit-Latch BCD zu
Dezimal

SN 74148

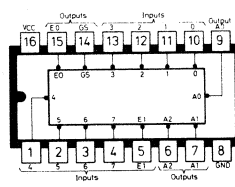

Binärer 8 zu 3 Prioritätsentk.

SN 74155

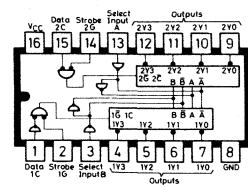

Zwei 2-Bit-Binärdek. / Demultipl.

SN 74143

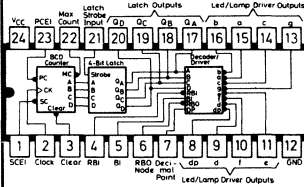

Dezimal., 4-Bit-Latch

SN 74150

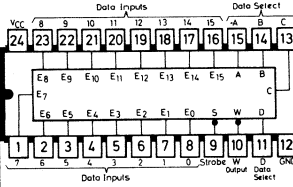

16 zu 10 Datenselektor

SN 74156

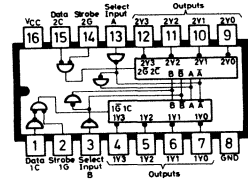

Zwei 2-Bit-Binärdek. / Demultipl.

SN 74144

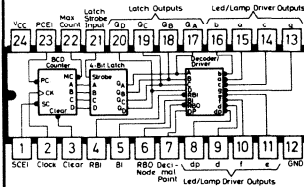

Dezimal., 4-Bit-Latch

SN 74151

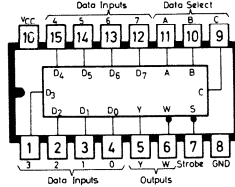

8 zu 1 Datenselektor / Multipl.

SN 74157

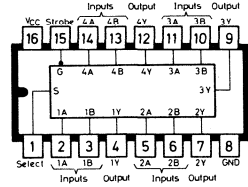

Vier 2 zu 1 Datenselekt. / Multipl.

SN 74145

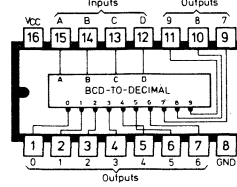

BCD zu Dezimal-Dek. Anzeigent.

SN 74153

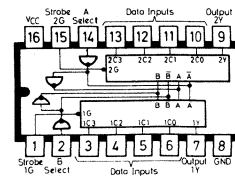

Zwei 4 zu 1 Datenselekt. / Multipl.

SN 74159

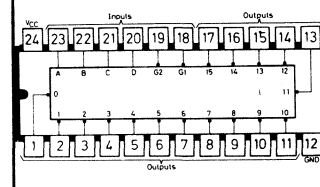

4-Bit Binärdek. / Demultipl.

Anschlußbelegungen von TTL-ICs

SN 74160

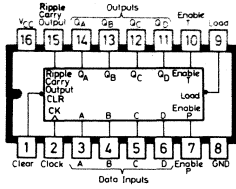

Synchr. programmierbarer Dezim.Zähler

SN 74165

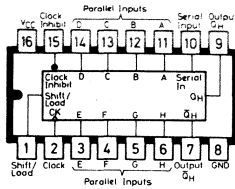

8-Bit-Schieberegister

SN 74173

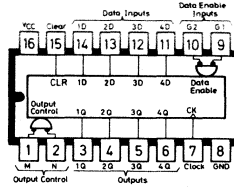

4-Bit-D-Reg. mit Enable, Clear

SN 74161

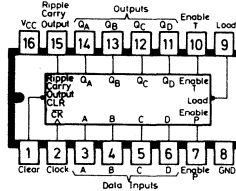

Synchr. programmierbarer 4-Bit Binär-Zähler

SN 74166

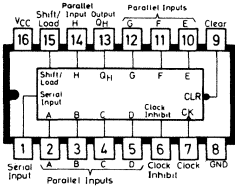

8-Bit-Schieberegister mit Clear

SN 74174

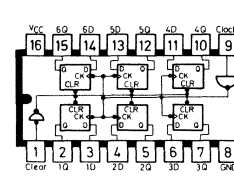

6-Bit-D-Register mit Clear

SN 74162

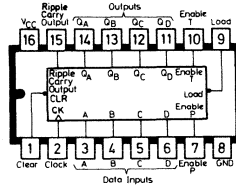

Synchr. programmierb. Dezim.-Z.

SN 74167

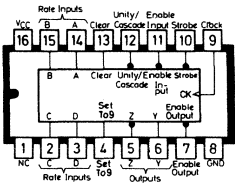

Synchr. programmierb. Frequenz-T.

SN 74176

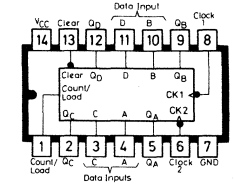

Programmierb. Dezimalzähler

SN 74163

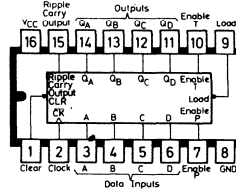

Synchr. progr. 4-Bit-Binärz.

SN 74170

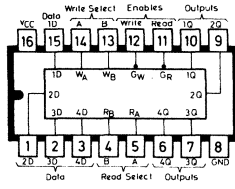

16-Bit-Register File off. Koll.

SN 74177

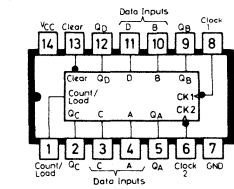

Programmierb. 4-Bit-Bin.-Z.

SN 74164

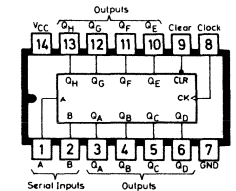

8-Bit-Schieberegister

SN 74172

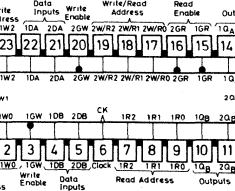

16-Bit-Register Tile mit Tri-State

SN 74178

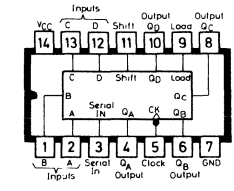

4-Bit-Schieberegister

Anschlußbelegungen von TTL-ICs

SN 74179

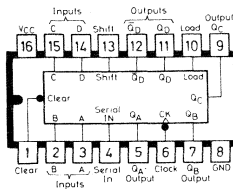

4-Bit-Schieberegister

SN 74180

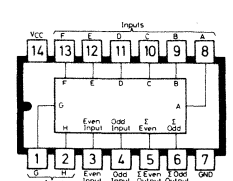

9-Bit-Paritätsgenerator

SN 74181

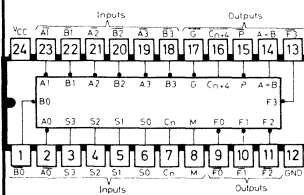

4-Bit arithm. Log. Einheit

SN 74182

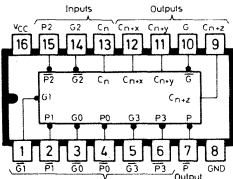

Übertragungseinheit für Rechen-Schaltung

SN 74 LS 183

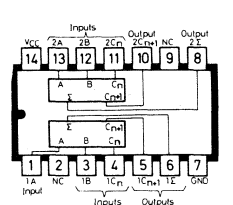

Zwei 1-Bit-Volladdierer

SN 74184

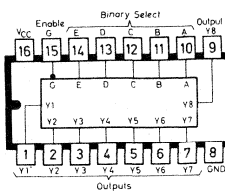

BCD zu Binär-Kodeumsetzer

SN 74185

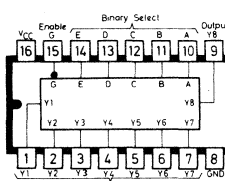

Binär zu BCD-Kodeumsetzer

SN 74190

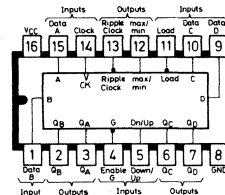

Synchr. programmierb. Zähler

SN 74191

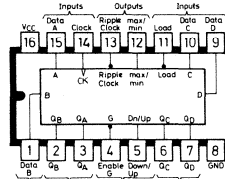

Synchr. programmierb. Zähler

SN 74192

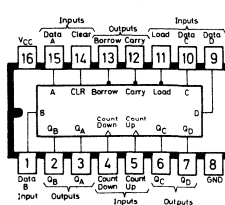

Synchr. programmierb. Dezimal-zähler

SN 74193

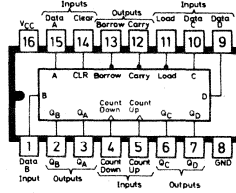

Synchr. programmierb. 4-Bit-Binärzähler

SN 74194

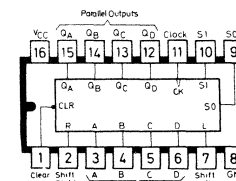

4-Bit-Univers.-Schieberegister

SN 74195

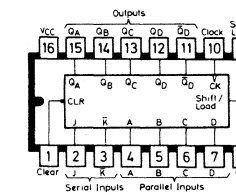

4-Bit-Schieberegister

SN 74196

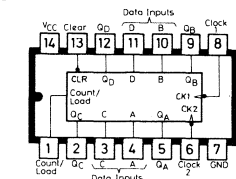

Programmierb. Dezimalzähler

SN 74197

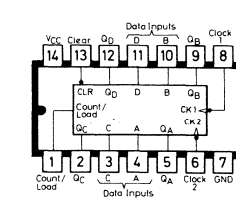

Programmierb. 4-Bit-Binärzähler

Anschlußbelegungen von TTL-ICs

SN 74198

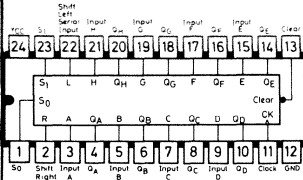

8-Bit-Universalschieberegister

SN 74199

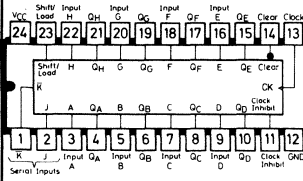

8-Bit-Schieberegister

SN 74221

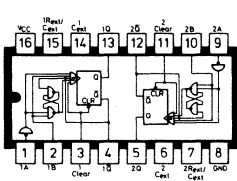

Zwei Monoflops mit Schmitt-Trigger

SN 74 LS 240

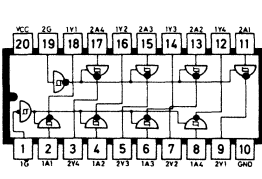

Acht inv. Bus-Leistungstreiber

SN 74 LS 241

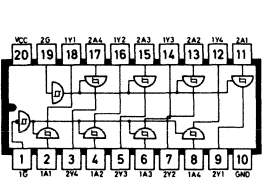

Acht Bus-Leistungstreiber

SN 74 LS 242

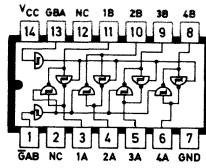

Vier invert. Bus-Transceiver

SN 74 LS 244

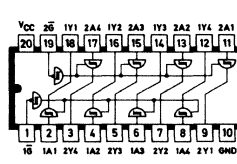

Acht Bus-Leistungstreiber

SN 74 LS 245

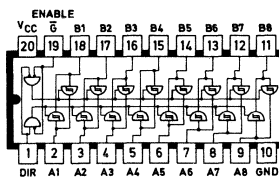

Acht Bus-Transceiver

SN 74246

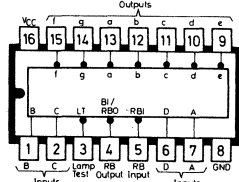

BCD zu 7-Segm.-Dekoder

SN 74247

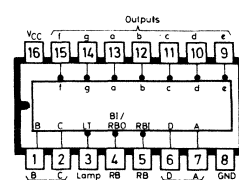

BCD zu 7-Segm.-Dekoder

SN 74248

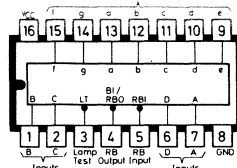

BCD zu 7-Segm.-Dekoder

SN 74249

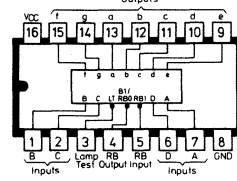

BCD zu 7-Segm.-Dekoder

SN 74251

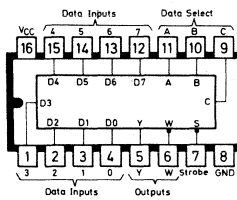

8 zu 1 Datenselektor/Multipl.

SN 74 LS 253

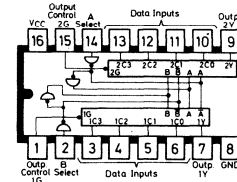

Zwei 4 zu 1 Datenselektor/Multipl.

SN 74259

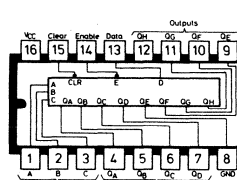

Adressierb. 8-Bit Latch

Anschlußbelegungen von TTL-ICs

SN 74265

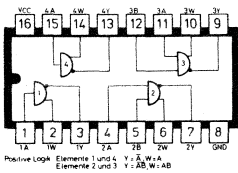

Zwei Inverter u. zwei NAND-Gatter

SN 74 LS 266

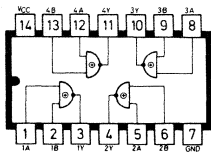

Vier Exl.-NOR-Gatter

SN 74273

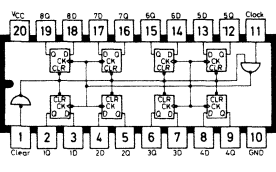

8-Bit-D-Register mit Clear

SN 74 LS 275

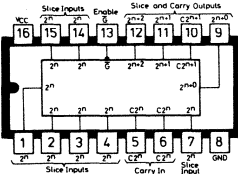

7-Bit-Ballace-Tree-Element

SN 74276

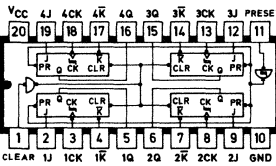

Vier J-K-Flipflops mit Preset

SN 74278

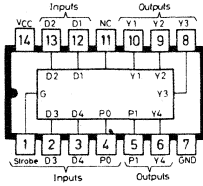

Kaskadierbares 4-Bit-Latch

SN 74279

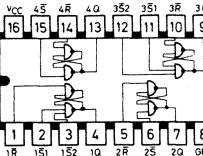

Vier R-S-Latches

SN 74 LS 280

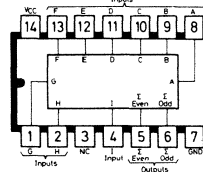

9-Bit-Prioritätsgen.

SN 74283

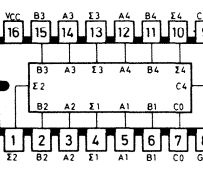

4-Bit-Volladdierer

SN 74284

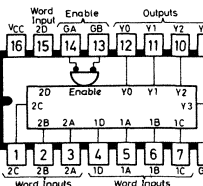

4-Bit x 4-Bit-Multiplizierer

SN 74290

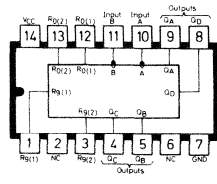

Dezimalzähler

SN 74293

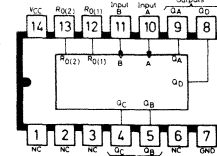

4-Bit-Binärzähler

SN 74 LS 295

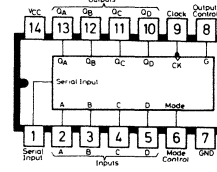

4-Bit-Schieberegister

SN 74298

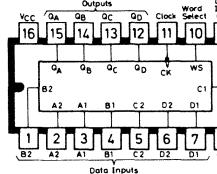

Vier 2 zu 1 Datenselekt.

SN 74 LS 299

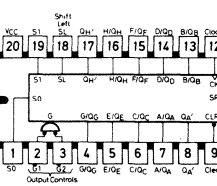

8-Bit-Univ.-Schieberegister

Anschlußbelegungen von TTL-ICs

SN 74 LS 320

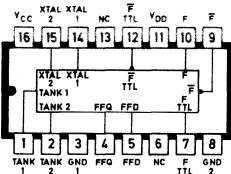

Quarzgesteuerter Oszillator

SN 74 LS 322

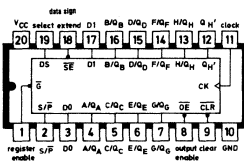

8-Bit-Schieberegister

SN 74 LS 325

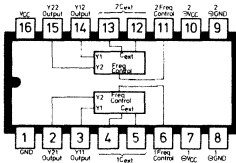

Zwei spannungsgest. Oszill.

SN 74 LS 347

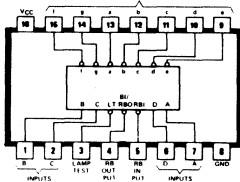

BCD zu 7-Segm.-Dekoder

SN 74351

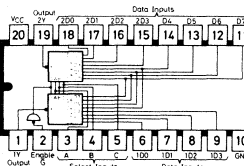

Zwei 8 zu 1 Datenselektoren

SN 74365

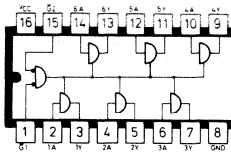

Sechs Bus-Leistungstreiber

SN 74366 (LS)

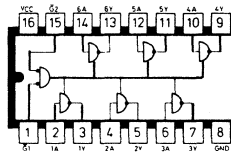

Sechs invert. Bus-Leistungstr.

SN 74367 (LS)

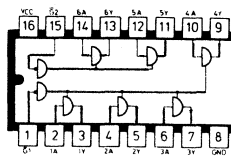

Sechs Bus-Leistungstreiber

SN 74368 (LS)

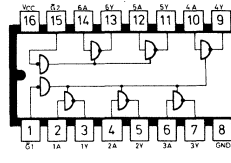

Sechs inv. Bus-Leistungstreiber

SN 74376

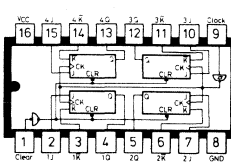

4-Bit-J-K-Register mit Clear

SN 74390

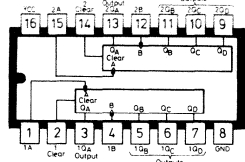

Zwei Dezimalzähler

SN 74393 (LS)

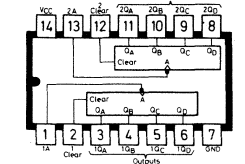

Zwei 4-Bit-Binärzähler

SN 74425

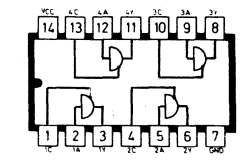

Vier Bus-Leistungstreiber

SN 74426

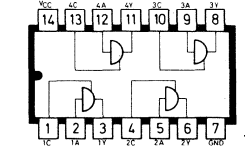

Vier Bus-Leistungstreiber

SN 74490

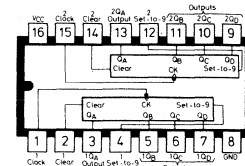

Zwei Dezimalzähler

Anschlußbelegungen von C-MOS ICs CD/HEF/MC 1...

4000

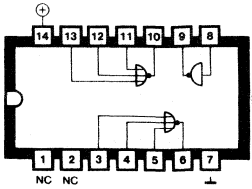

Zwei NOR-Gatter mit je 3 Eing.

4001

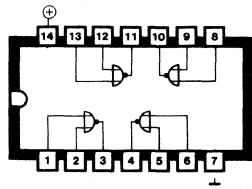

Vier NOR-Gatter mit je Eingang

4002

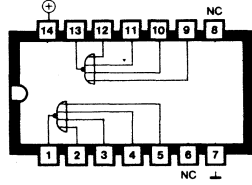

Zwei NOR-Gatter mit je 4 Eing.

4006

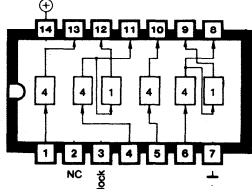

Schieberegister

4007

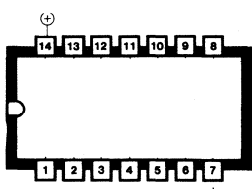

Zwei CMOS-Paare plus Inverter

4008

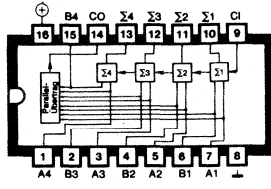

4-Bit-Voll-Addierer

4009

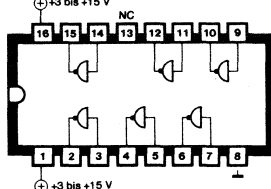

Sechs invertierende Puffer

4010

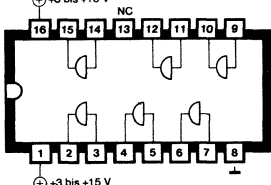

Sechs nicht invertierende Puffer

4011

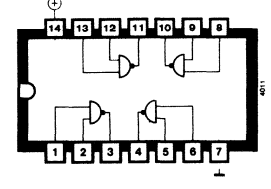

Vier NAND-Gatter mit je 2 Eing.

4012

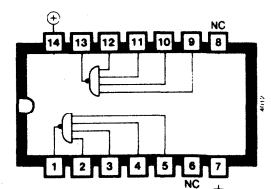

Zwei NAND-Gatter mit je 4 Eing.

4013

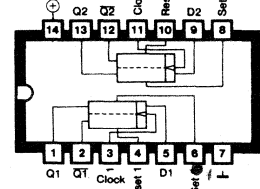

Zwei D-Flipflops

4014

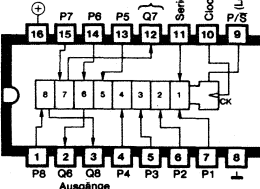

8-stufiges Schieberegister

4015

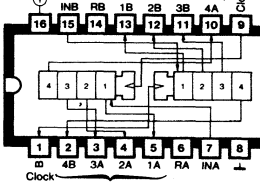

Zwei 4-stufige Schieberegister

4016

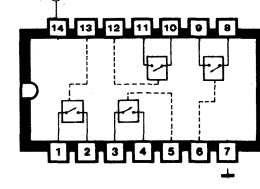

Vier digitale o. analoge b. Schalter

4017

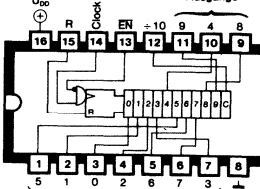

Dezimalzähler mit 10 dekod. Ausg.

Anschlußbelegungen von C-MOS ICs CD/HEF/MC 1...

4018

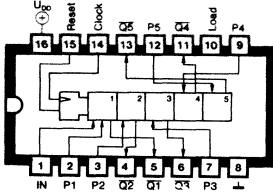

Programmierz. Zähler/Teiler 2...10

4023

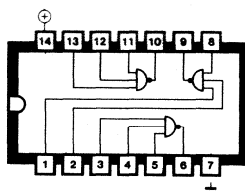

Drei NAND-Gatter mit je 3 Eing.

4028

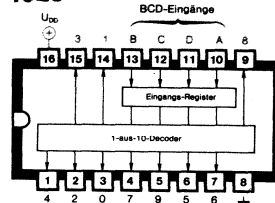

BCD-zu-Dezim.-Dekoder

4019

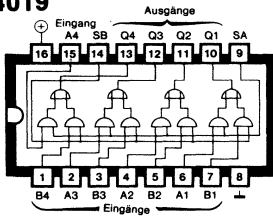

4 gemeinsam adressierb. Multipl.

4024

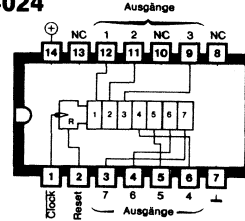

Asynchroner 7stuf. Bin.-Zähler

4029

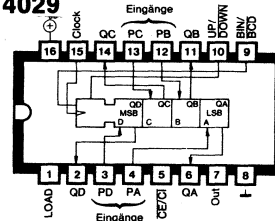

Aufw./Abw.-Zähler durch 10

4020

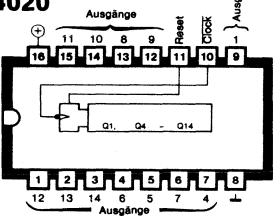

14-stufiger Binärzähler

4025

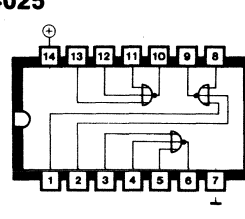

Drei NOR-Gatter mit je 3 Eing.

4030

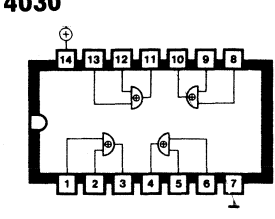

Vier Exkl.-ODER-Gatter

4021

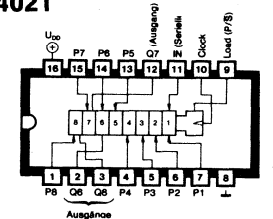

8-stufiges Schieberegister

4026

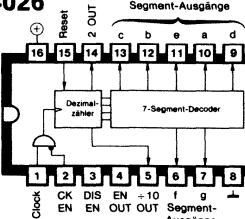

Dezim.-Zähler mit dek. 7-Segm.-Ausg.

4031

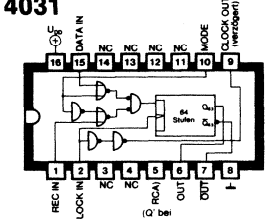

64stuf. Schieberegister

4022

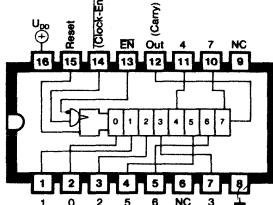

Oktalzähler mit 8 dekod. Ausg.

4027

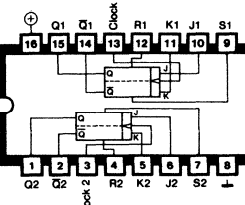

Zwei JK-Flipflops

4032

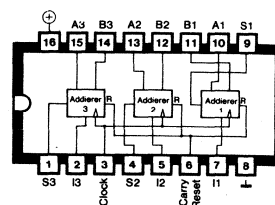

Dreif. serieller Addierer

Anschlußbelegungen von C-MOS ICs CD/HEF/MC 1...

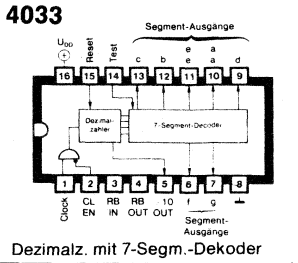

Dezimalz. mit 7-Segm.-Dekoder

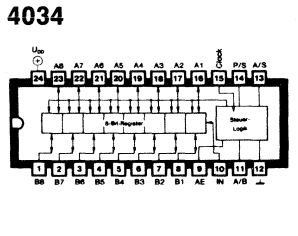

Bidirektionales Bus-Register

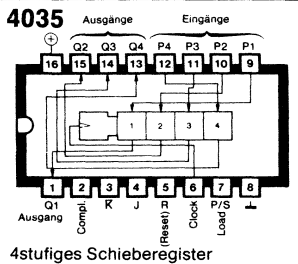

4stufiges Schieberegister

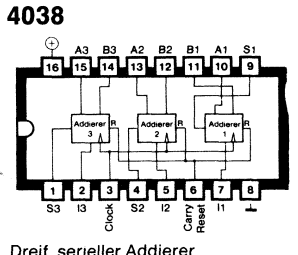

Dreif. serieller Addierer

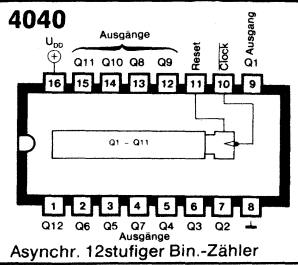

Asynchr. 12stufiger Bin.-Zähler

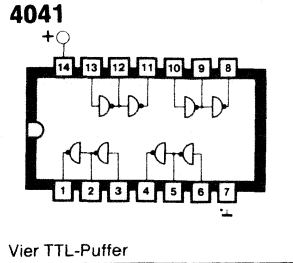

Vier TTL-Puffer

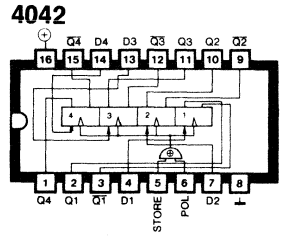

Vier-Speicher-Register

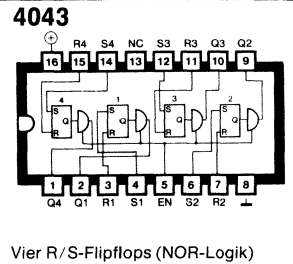

Vier R/S-Flipflops (NOR-Logik)

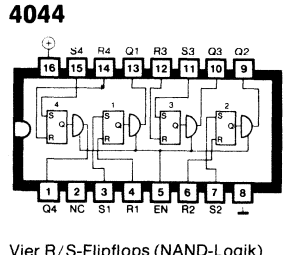

Vier R/S-Flipflops (NAND-Logik)

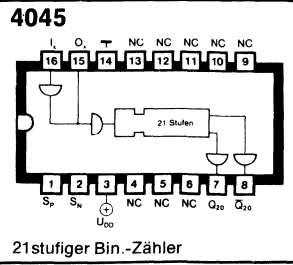

21stufiger Bin.-Zähler

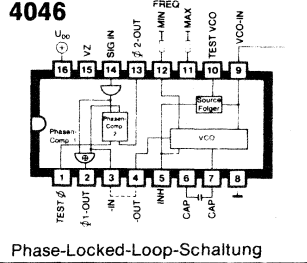

Phase-Locked-Loop-Schaltung

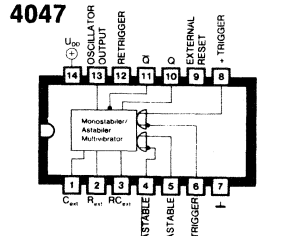

Monostab./ Astabiler Multivibr.

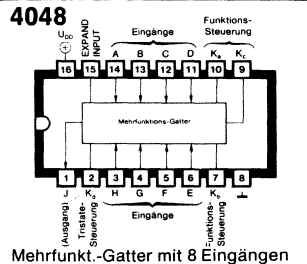

Mehrfunkt.-Gatter mit 8 Eingängen

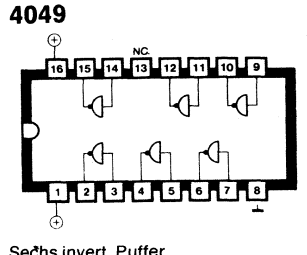

Sechs invert. Puffer

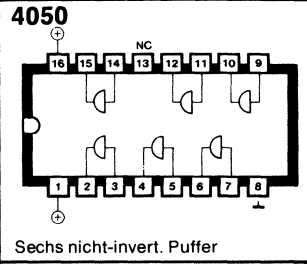

Sechs nicht-invert. Puffer

Anschlußbelegungen von C-MOS ICs CD/HEF/MC 1...

4051

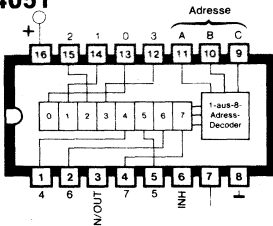

1-aus-8-Schalter

4056

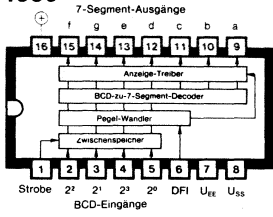

BCD zu 7-Segm.-Speicher, Dek./Tr.

4068

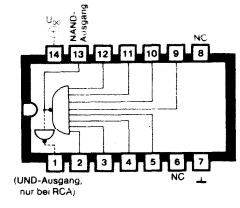

NAND-Gatter mit 8 Eingängen

4052

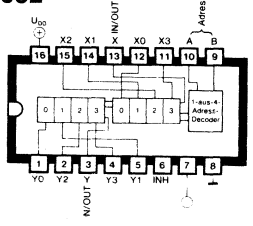

Zwei 1-aus-4-Schalter

4060

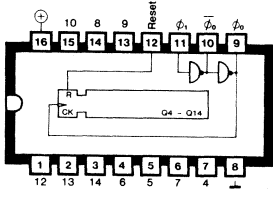

14stuf. Binärzähler

4069

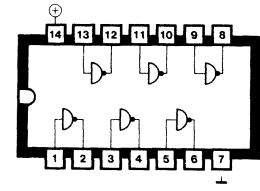

Sechs Inverter

4053

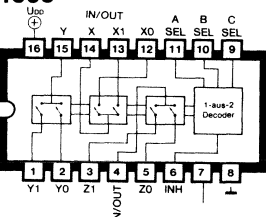

Drei 1-aus-2-Schalter

4063

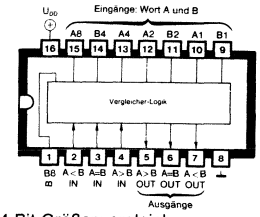

4-Bit-Größenvergleich

4070

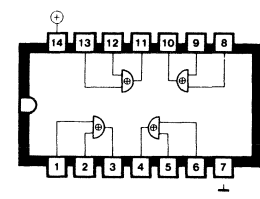

Vier Exkl. ODER-Gatter mit 2 Eing.

4054

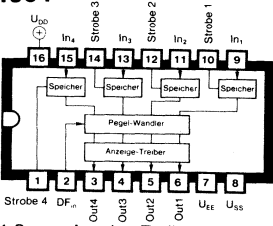

4-Segm.-Anzeige-Treiber

4066

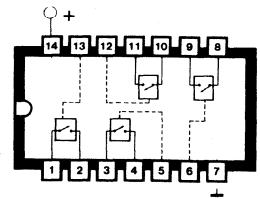

Vier digitale o. anal. Schalter

4071

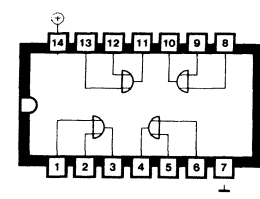

Vier ODER-Gatter mit je 2 Eing.

4055

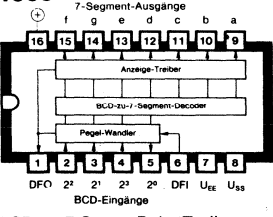

BCD zu 7-Segm.-Dek./Treiber

4067

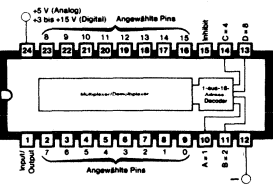

1-aus-16-Multipl./Demultipl.

4072

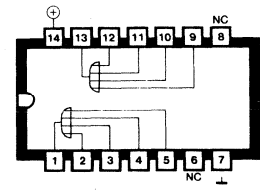

Zwei ODER-Gatter mit je 4 Eing.

Anschlußbelegungen von C-MOS ICs CD/HEF/MC 1...

4073

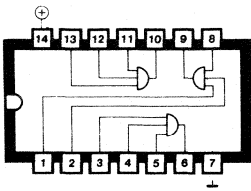

Drei UND-Gatter mit je 3 Eing.

4081

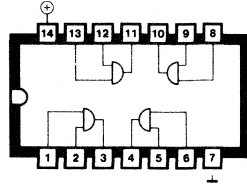

Vier UND-Gatter mit je 2 Eing.

4093

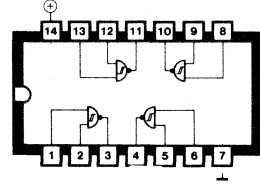

Vier NAND-Schmitt-Trigger

4075

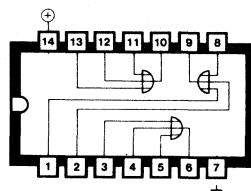

Drei ODER-Gatter mit je 3 Eing.

4082

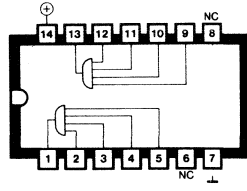

Zwei UND-Gatter mit je 4 Eing.

4094

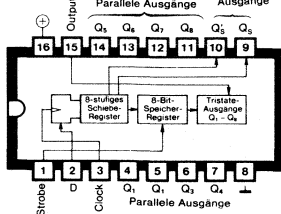

8stufiges Schieberegister

4076

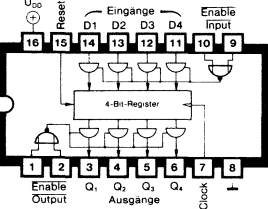

Vier D-Register Tristate

4085

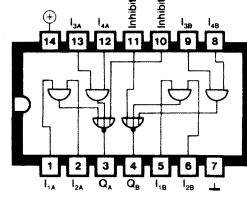

Zwei UND-ODER-NICHT-Gatter

4095

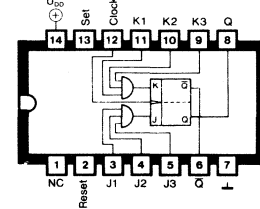

JK-Master-Slave-Flipflop

4077

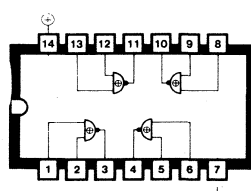

Vier Exklusiv-NOR-Gatter

4086

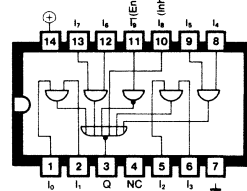

UND-ODER-NICHT-Gatter

4096

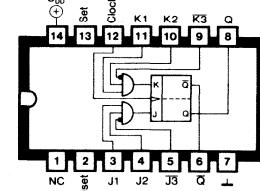

JK-Master-Slave-Flipflop

4078

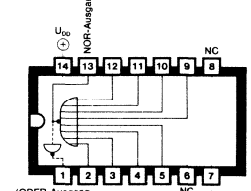

NOR-Gatter mit 8 Eingängen

4089

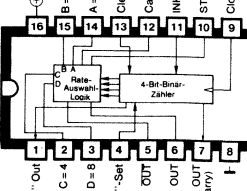

Binärer Rate-Multiplier

4097

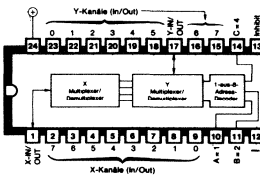

Zwei 1-aus-8-Schalter

Anschlußbelegungen von C-MOS ICs CD/HEF/MC 1...

4098

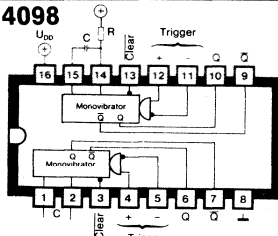

Zwei retriggerb. Monovibrat.

4504

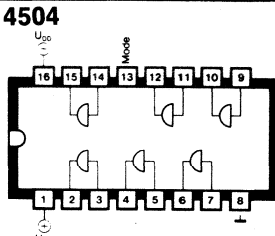

Sechs Pegelwandler

4511

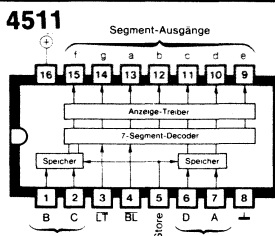

BCD-7-Segm.-Speicher/Dek.-Tr.

4099

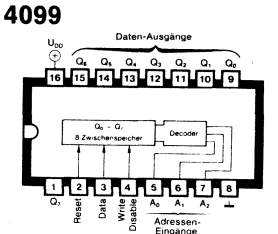

Adressierb. 8-Bit-Zwischensp.

4506

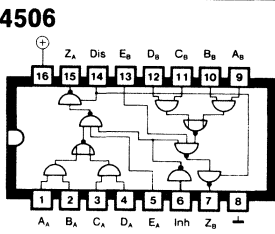

Zwei exp. UND-ODER-INV.-Gatter

4512

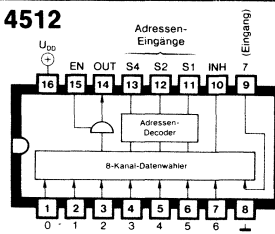

8kan. Datenzähler

4501

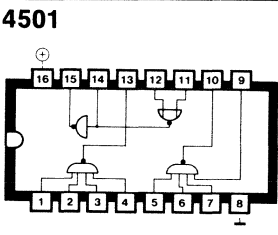

Dreifach-Gatter

4507

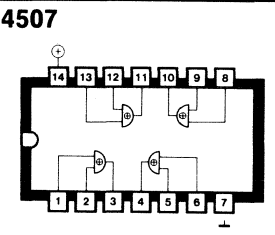

Vier Exklusiv-ODER-Gatter

4513

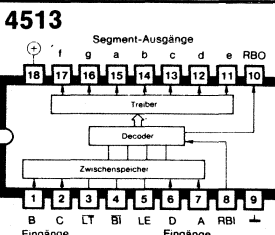

BCD-zu-7-Segm.-Speicher-Dek.

4502

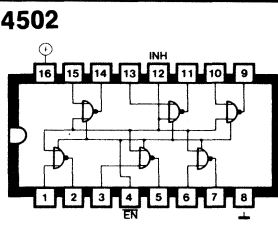

Sechs Inverter/Treiber

4508

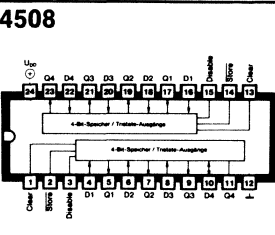

Zwei 4-Bit-Speicher-Register

4514

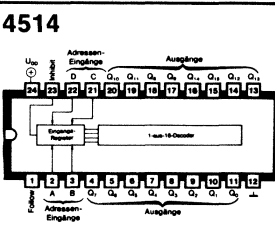

1-aus-16-Dekoder

4503

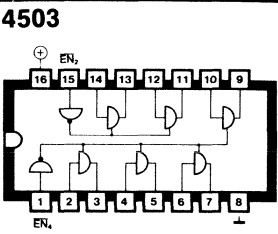

Sechs Puffer/Treiber

4510

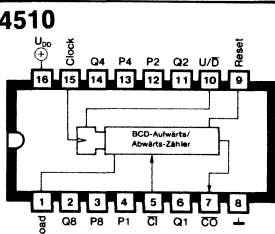

BCD-Dezimalzähler

4515

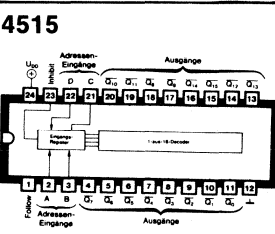

1-aus-16-Dekoder

Anschlußbelegungen von C-MOS ICs CD/HEF/MC 1...

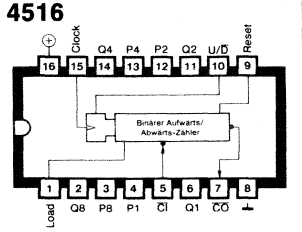

Binärer Auf/ Ab-Zähler

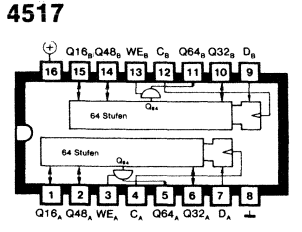

Zwei stat. 64st. Schieberegister

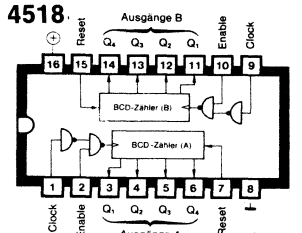

Zwei BCD-Zähler

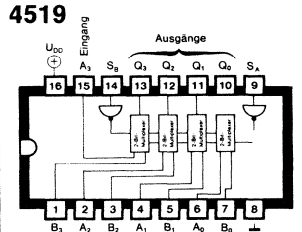

Vier gem. 2-Bit-Multiplexer

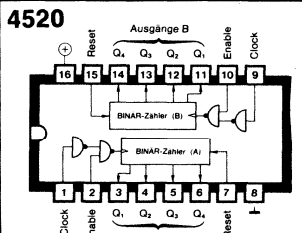

Zweif. bin.-Aufwärtszähler

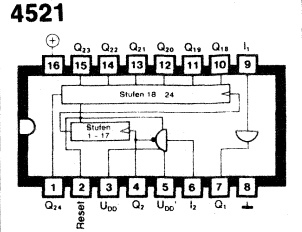

24stufiger Binärzähler

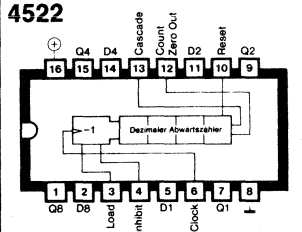

Programmierbarer Dezimalzähler

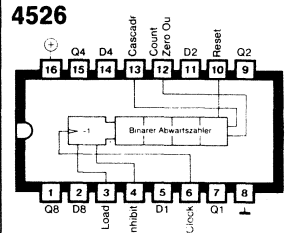

Programmierbarer Binärzähler

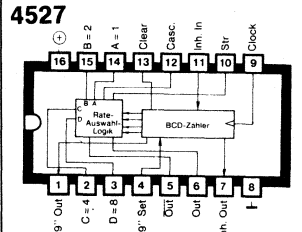

Dezimaler Rate-Multiplier

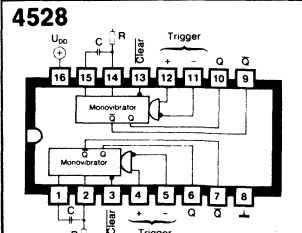

Zwei retriggerb. Monovibr.

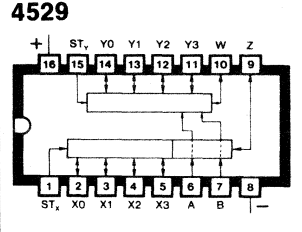

Zwei 4-Kanal-Selektoren

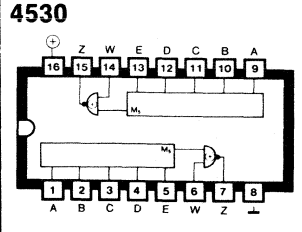

Zwei Majoritätslogik-Gatter

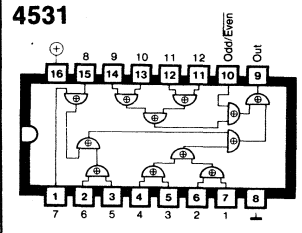

Paritäts-Prüfer mit 13 Eingängen

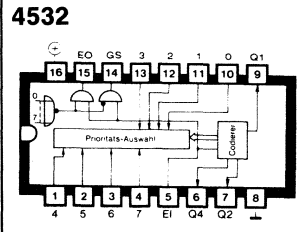

Prioritäts-8-Bit-Dekoder

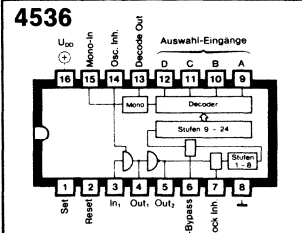

Programmierb. Zeitgeber

Anschlußbelegungen von C-MOS ICs CD/HEF/MC 1...

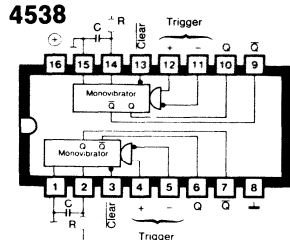

Zwei retriggerb. Monost.-Multivibr.

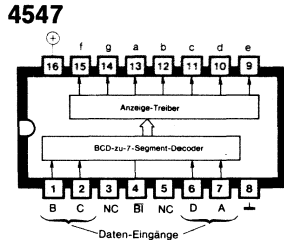

BCD-7-Segm.-Dek. und Treiber

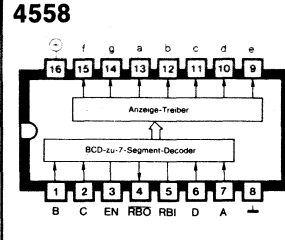

BCD-zu-7-Segm.-Dekoder

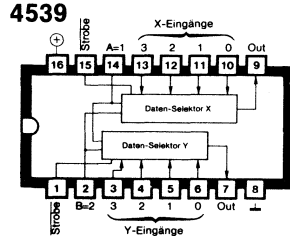

Zwei Multipl. mit 4 Eingängen

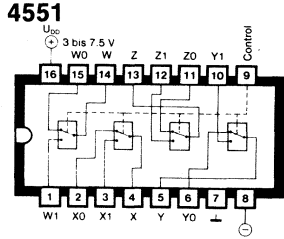

Vier Anal.-Multipl./Demultipl.

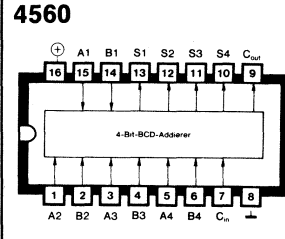

4-Bit-BCD-Addierer

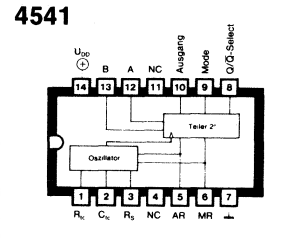

Programmierb. Timer

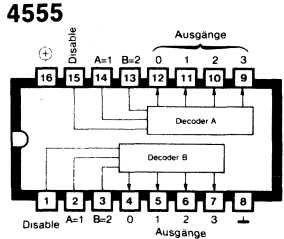

Zwei 1-aus-4-Dek.-Multipl.

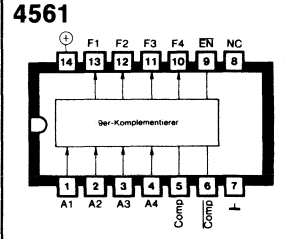

9er-Komplementierer

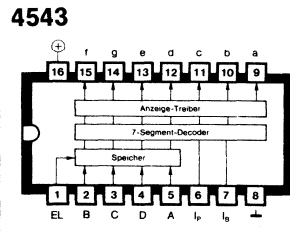

BCD-7-Segm.-Dekoder/Treiber

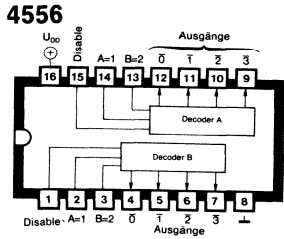

Zwei 1-aus-4-Dek.-Multipl.

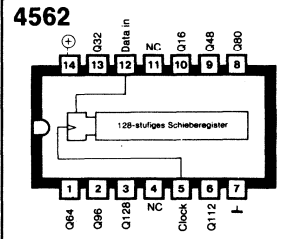

128stuf. stat. Schieberegister

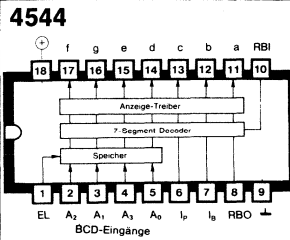

BCD-7-Segm.-Speicher, Dek./Treiber

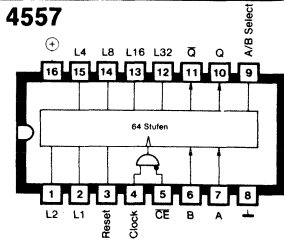

Variables Schieberegister 1 bis 64

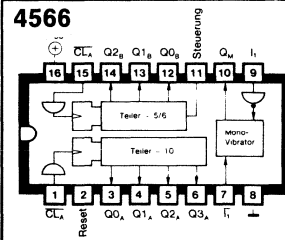

Zeitbasis-Generator

Anschlußbelegungen von C-MOS ICs CD/HEF/MC 1...

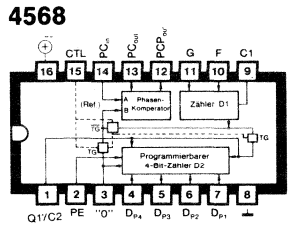

Phasenkomp. und progr. Zähler

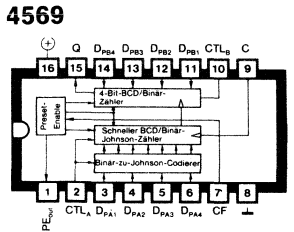

Programmierb. Teiler durch N

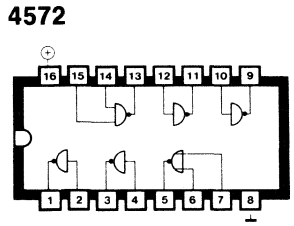

Sechs Gatter 4 Inv., 1 NOR, 1 NAND

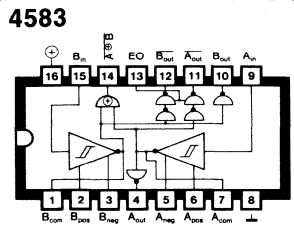

Zwei einstellb. Schmitt-Trigger

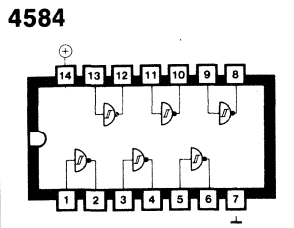

Sechs Schmitt-Trigger

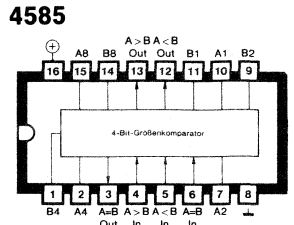

4-Bit-Größen-Vergleicher

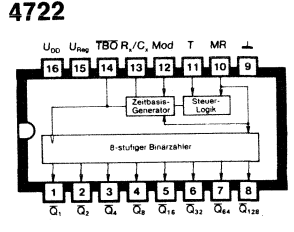

Progr. Zeitg.-Zähler

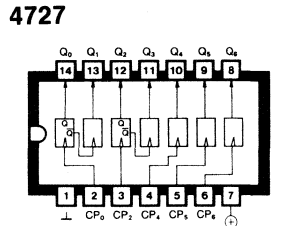

7stufiger Zähler

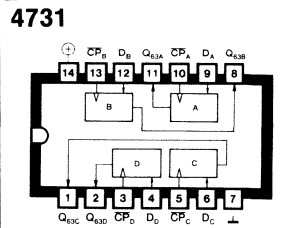

Vier stat. 64-Bit-Schiebereg.

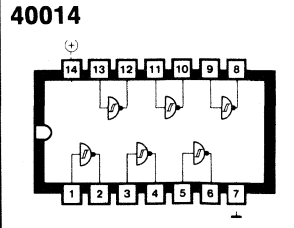

Sechs Schmitt-Trigger

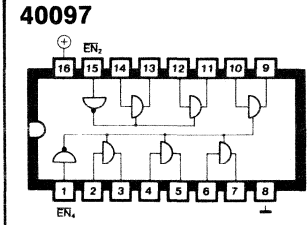

Sechs nicht-invert. Treiber

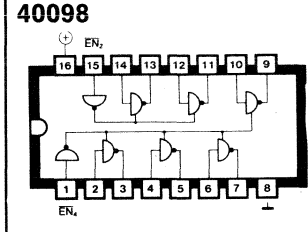

Sechs invert. Treiber

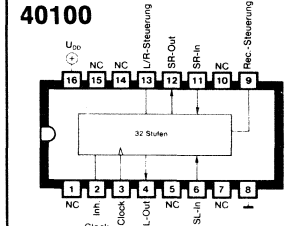

32stuf. stat. l/r Schieberegister

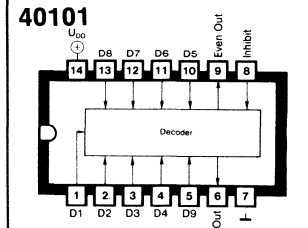

9-Bit-Paritäts-Gen.

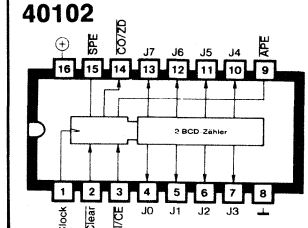

Achtstell. voreinstellb. Zähler

Anschlußbelegungen von C-MOS ICs CD/HEF/MC 1...

40103

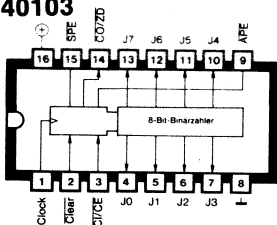

8stuf. vorsetzb. synchr. Zähler

40160

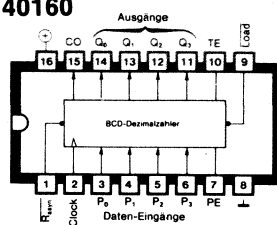

Synchr. BCD-Zähler m. Rückst.

40192

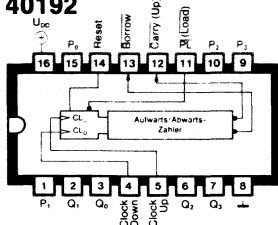

Synchr. Auf/ Ab BCD-Dezim.-Zähler

40106

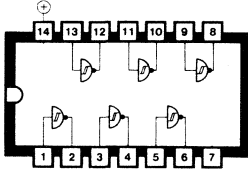

Sechs Schmitt-Trigger

40161

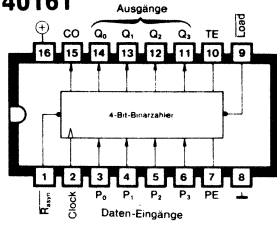

Synchr. 4-Bit.-Bin.-Zähler

40193

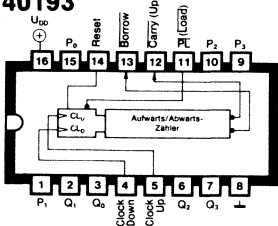

Synchr. Auf/AB-4-Bit.-Bin.-Zähler

40107

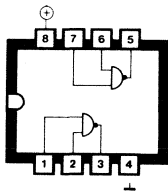

Zwei NAND-Puffer-Treiber

40162

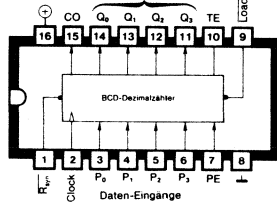

Synchr. BCD-Dezim.-Zähler

40194

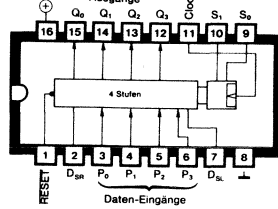

4-Bit-Schieberegister

40109

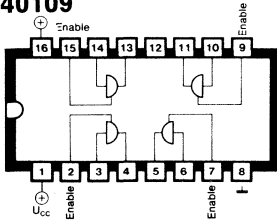

Vier Pegelwandler mit Tristate

40174

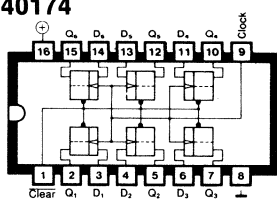

Sechs D-Zwischensp. Flipflops

40195

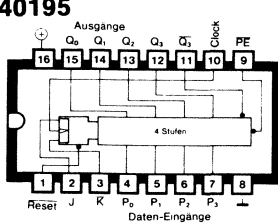

4-Bit-Schiebereg. mit synchr. Eing.

40147

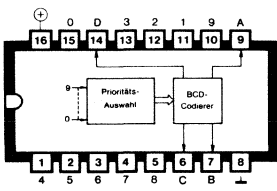

10-zu-4-Leitung. BCD-Codierer

40175

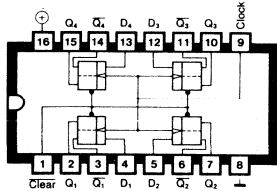

Vier D-Zwischensp. Flipflops

Typenübersicht MOS-FET	
Typ	Bild
BSS 87	1
BSS 89	2
BSS 91	3
BSS 92	1
BSS 95	4
BSS 97	4
BSS 100	5
BSS 101	5
BSS 110	5
BSS 123	6
BUZ 10	7
BUZ 10 A	7
BUZ 11	7
BUZ 11 A	7
BUZ 14	8
BUZ 15	8
BUZ 17	9
BUZ 18	9
BUZ 20	7
BUZ 21	7
BUZ 23	8
BUZ 24	8
BUZ 25	8
BUZ 27	9
BUZ 28	9
BUZ 31	7
BUZ 32	7
BUZ 34	8
BUZ 35	8
BUZ 36	8
BUZ 37	9
BUZ 38	9
BUZ 41 A	7
BUZ 42	7
BUZ 44 A	8
BUZ 45	8
BUZ 45 A	8
BUZ 45 B	8
BUZ 46	8
BUZ 48	9
BUZ 48 A	9
BUZ 50 A	7

Technische Kurzdaten				
Typ	V_{DS} V	I_D A	$R_{DS(on)}$ Ω	Gehäuse

$V_{DS} = 50 \text{ V}$

BUZ 71	50	12	0,10	TO 220
BUZ 71A	50	12	0,12	TO 220
BUZ 10	50	19	0,10	TO 220
BUZ 10A	50	17	0,12	TO 220
BUZ 11A	50	25	0,06	TO 220
BUZ 11	50	30	0,04	TO 220
BUZ 14	50	39	0,04	TO 3
BUZ 15	50	45	0,03	TO 3
BUZ 17	50	32	0,04	TO 238
BUZ 18	50	37	0,03	TO 238

$V_{DS} = 100 \text{ V}$

BUZ 72	100	10	0,20	TO 220
BUZ 72A	100	9,0	0,25	TO 220
BUZ 20	100	12	0,20	TO 220
BUZ 21	100	19	0,10	TO 220
BUZ 23	100	10	0,20	TO 3
BUZ 25	100	19	0,10	TO 3
BUZ 24	100	32	0,06	TO 3
BUZ 28	100	18	0,10	TO 238
BUZ 27	100	26	0,06	TO 238

$V_{DS} = 200 \text{ V}$

BUZ 73	200	7,0	0,40	TO 220
BUZ 73A	200	5,8	0,60	TO 220
BUZ 32	200	9,5	0,40	TO 220
BUZ 31	200	12,5	0,20	TO 220
BUZ 35	200	9,9	0,40	TO 3
BUZ 34	200	14,0	0,20	TO 3
BUZ 36	200	22,0	0,12	TO 3
BUZ 37	200	13,0	0,20	TO 238
BUZ 38	200	18,0	0,12	TO 238

$V_{DS} = 400 \text{ V}$

BUZ 76A	400	2,6	2,5	TO 220
BUZ 76	400	3,0	1,8	TO 220
BUZ 60B	400	4,5	1,5	TO 220
BUZ 60	400	5,5	1,0	TO 220
BUZ 351	400	11,5	0,4	TO 218
BUZ 382 ¹⁾	400	11,0	0,4	TO 218
BUZ 63B	400	4,5	1,5	TO 3
BUZ 63	400	5,9	1,0	TO 3
BUZ 64	400	11,5	0,4	TO 3
BUZ 201 ¹⁾	400	10,5	0,4	TO 3
BUZ 67	400	9,6	0,4	TO 238

Typenübersicht MOS-FET	
Typ	Bild
BUZ 50 B	7
BUZ 53 A	8
BUZ 54	8
BUZ 54 A	8
BUZ 57 A	9
BUZ 58	9
BUZ 58 A	9
BUZ 60	7
BUZ 60 B	7
BUZ 63	8
BUZ 63 B	8
BUZ 64	8
BUZ 67	9
BUZ 71	7
BUZ 71 A	7
BUZ 72	7
BUZ 72 A	7
BUZ 73	7
BUZ 73 A	7
BUZ 74	7
BUZ 74 A	7
BUZ 76	7
BUZ 76 A	7
BUZ 80	7
BUZ 80 A	7
BUZ 83	8
BUZ 83 A	8
BUZ 84	8
BUZ 84 A	8
BUZ 88	9
BUZ 88 A	9
BUZ 201	8
BUZ 210	8
BUZ 211	8
BUZ 307	10
BUZ 308	10
BUZ 351	10
BUZ 353	10
BUZ 354	10
BUZ 382	10
BUZ 385	10

Technische Kurzdaten				
Typ	V_{DS} V	I_b A	$R_{DS(on)}$ Ω	Gehäuse

$V_{DS} = 500 \text{ V}$

BUZ 74A	500	2,0	4,0	TO 220
BUZ 74	500	2,4	3,0	TO 220
BUZ 42	500	4,0	2,0	TO 220
BUZ 41A	500	4,5	1,5	TO 220
BUZ 353	500	9,6	0,6	TO 218
BUZ 354	500	8,3	0,8	TO 218
BUZ 385 ¹⁾	500	8,0	0,8	TO 218
BUZ 46	500	4,2	2,0	TO 3
BUZ 44A	500	4,8	1,5	TO 3
BUZ 45A	500	8,3	0,8	TO 3
BUZ 45	500	9,6	0,6	TO 3
BUZ 45B	500	10,0	0,5	TO 3
BUZ 210 ¹⁾	500	9,6	0,6	TO 3
BUZ 211 ¹⁾	500	9,0	0,8	TO 3
BUZ 48A	500	6,8	0,8	TO 238
BUZ 48	500	7,8	0,6	TO 238

$V_{DS} = 800 \text{ V}$

BUZ 80A	800	3,0	3,0	TO 220
BUZ 80	800	2,6	4,0	TO 220
BUZ 308	800	2,6	4,0	TO 218
BUZ 307	800	3,0	3,0	TO 218
BUZ 83	800	2,9	4,0	TO 3
BUZ 83A	800	3,4	3,0	TO 3
BUZ 84	800	5,3	2,0	TO 3
BUZ 84A	800	6,0	1,5	TO 3
BUZ 88	800	4,3	2,0	TO 238
BUZ 88A	800	5,0	1,5	TO 238

$V_{DS} = 1000 \text{ V}$

BUZ 50B	1000	2,0	8,0	TO 220
BUZ 50A	1000	2,5	5,0	TO 220
BUZ 53A	1000	2,6	5,0	TO 3
BUZ 54A	1000	4,6	2,6	TO 3
BUZ 54	1000	5,3	2,0	TO 3
BUZ 57A	1000	2,5	5,0	TO 238
BUZ 58A	1000	3,7	2,6	TO 238
BUZ 58	1000	4,3	2,0	TO 238

¹⁾ Mit schneller Inversdiode

MOS-Feldeffekttransistoren-Vergleichstabelle

Typ	BUZ-Vergleichstyp	BUZ-Anschlußbild	Typ	BUZ-Vergleichstyp	BUZ-Anschlußbild
IRF 120	BUZ 23	8	IRF 621	BUZ 73A	7
IRF 121	BUZ 23	8	IRF 622	BUZ 73A	7
IRF 122	BUZ 23	8	IRF 623	BUZ 73A	7
IRF 123	BUZ 23	8	IRF 630	BUZ 32	7
IRF 130	BUZ 25	8	IRF 631	BUZ 32	7
IRF 131	BUZ 25	8	IRF 632	BUZ 32	7
IRF 132	BUZ 23	8	IRF 633	BUZ 32	7
IRF 133	BUZ 23	8	IRF 640	BUZ 31	7
IRF 140	BUZ 24	8	IRF 641	BUZ 31	7
IRF 141	BUZ 14	8	IRF 642	BUZ 31	7
IRF 142	BUZ 25	8	IRF 643	BUZ 31	7
IRF 143	BUZ 25	8	IRF 710	BUZ 76A	7
IRF 150	BUZ 24	8	IRF 711	BUZ 76A	7
IRF 151	BUZ 14	8	IRF 712	BUZ 76A	7
IRF 152	BUZ 24	8	IRF 713	BUZ 76A	7
IRF 153	BUZ 14	8	IRF 720	BUZ 76	7
IRF 230	BUZ 35	8	IRF 721	BUZ 76	7
IRF 231	BUZ 35	8	IRF 722	BUZ 76A	7
IRF 240	BUZ 36	8	IRF 723	BUZ 76A	7
IRF 241	BUZ 36	8	IRF 730	BUZ 60	7
IRF 242	BUZ 34	8	IRF 731	BUZ 60	7
IRF 243	BUZ 34	8	IRF 732	BUZ 60B	7
IRF 320	BUZ 63B	8	IRF 733	BUZ 60B	7
IRF 321	BUZ 63B	8	IRF 740	BUZ 64	7
IRF 322	BUZ 63B	8	IRF 741	BUZ 64	7
IRF 323	BUZ 63B	8	IRF 742	BUZ 60	7
IRF 330	BUZ 63	8	IRF 743	BUZ 60	7
IRF 331	BUZ 63	8	IRF 820	BUZ 74	7
IRF 332	BUZ 63B	8	IRF 821	BUZ 74	7
IRF 333	BUZ 63B	8	IRF 822	BUZ 74A	7
IRF 340	BUZ 64	8	IRF 823	BUZ 74A	7
IRF 341	BUZ 64	8	IRF 830	BUZ 41A	7
IRF 350	BUZ 64	8	IRF 831	BUZ 41A	7
IRF 351	BUZ 64	8	IRF 832	BUZ 42	7
IRF 352	BUZ 64	8	IRF 833	BUZ 42	7
IRF 353	BUZ 64	8	MTM 474	BUZ 46	8
IRF 420	BUZ 46	8	MTM 475	BUZ 46	8
IRF 421	BUZ 46	8	MTM 564	BUZ 63B	8
IRF 430	BUZ 44A	8	MTM 565	BUZ 63B	8
IRF 431	BUZ 44A	8	MTM 814	BUZ 23	8
IRF 432	BUZ 46	8	MTM 815	BUZ 23	8
IRF 433	BUZ 46	8	MTM 1224	BUZ 23	8
IRF 440	BUZ 45A	8	MTM 1225	BUZ 23	8
IRF 441	BUZ 45A	8	MTM 3N55	BUZ 46	8
IRF 442	BUZ 45A	8	MTM 3N60	BUZ 84	8
IRF 443	BUZ 45A	8	MTM 5N35	BUZ 63B	8
IRF 450	BUZ 45B	8	MTM 5N40	BUZ 63B	8
IRF 451	BUZ 45B	8	MTM 7N45	BUZ 45A	8
IRF 452	BUZ 45B	8	MTM 7N50	BUZ 45A	8
IRF 453	BUZ 45B	8	MTM 8N35	BUZ 64	8
IRF 520	BUZ 72A	7	MTM 8N40	BUZ 45A	8
IRF 521	BUZ 72A	7	MTP 474	BUZ 42	7
IRF 522	BUZ 72A	7	MTP 475	BUZ 42	7
IRF 523	BUZ 72A	7	MTP 564	BUZ 60B	7
IRF 530	BUZ 21	7	MTP 565	BUZ 60B	7
IRF 531	BUZ 10A	7	MTP 814	BUZ 72A	7
IRF 532	BUZ 20	7	MTP 815	BUZ 72A	7
IRF 533	BUZ 10A	7	MTP 1224	BUZ 20	7
IRF 540	BUZ 21	7	MTP 1225	BUZ 20	7
IRF 541	BUZ 21	7	MTP 1N95	BUZ 50B	7
IRF 542	BUZ 21	7	MTP 1N100	BUZ 50B	7
IRF 543	BUZ 11A	7	MTP 2N85	BUZ 50B	7
IRF 620	BUZ 73A	7	MTP 2N90	BUZ 50B	7

MOS-Feldeffekttransistoren-Vergleichstabelle

Typ	BUZ - Vergleichstyp	BUZ- Anschlußbild
MTP 3N55	BUZ 42	7
MTP 3N60	BUZ 80A	7
MTP 5N35	BUZ 60B	7
MTP 5N40	BUZ 60B	7
RCA 9192A	BUZ 23	8
RCA 9193	BUZ 46	8
RCA 9195A	BUZ 23	8
RCA 9195B	BUZ 34	8
RCA 9213A	BSS 97	4
RCA 9213B	BSS 97	4
RCA 9213C	BSS 97	4
RCA 9230A	BUZ 21	7
RCA 9230B	BUZ 31	7
RCA 9232	BUZ 74	7
IVN 6200CNH	BUZ 20	7
IVN 6200KNH	BUZ 23	8
IVN 6200CNM	BUZ 31	7
IVN 6200KNM	BUZ 34	8
IVN 6200CNU	BUZ 41A	7
IVN 6400KNU	BUZ 45	8
UFN 120	BUZ 23	8
UFN 121	BUZ 23	8
UFN 122	BUZ 23	8
UFN 123	BUZ 23	8
UFN 130	BUZ 25	8
UFN 131	BUZ 25	8
UFN 132	BUZ 23	8
UFN 133	BUZ 23	8
UFN 140	BUZ 24	8
UFN 141	BUZ 14	8
UFN 142	BUZ 25	8
UFN 143	BUZ 25	8
UFN 150	BUZ 24	8
UFN 151	BUZ 14	8
UFN 152	BUZ 24	8
UFN 153	BUZ 14	8
UFN 230	BUZ 35	8
UFN 231	BUZ 35	8
UFN 240	BUZ 36	8
UFN 241	BUZ 36	8
UFN 242	BUZ 34	8
UFN 243	BUZ 34	8
UFN 320	BUZ 63B	8
UFN 321	BUZ 63B	8
UFN 322	BUZ 63B	8
UFN 323	BUZ 63B	8
UFN 330	BUZ 63	8
UFN 331	BUZ 63	8
UFN 332	BUZ 63B	8
UFN 333	BUZ 63B	8
UFN 340	BUZ 64	8
UFN 341	BUZ 64	8
UFN 350	BUZ 64	8
UFN 351	BUZ 64	8
UFN 352	BUZ 64	8
UFN 353	BUZ 64	8
UFN 420	BUZ 46	8
UFN 421	BUZ 46	8
UFN 430	BUZ 44A	8
UFN 431	BUZ 44A	8
UFN 432	BUZ 46	8
UFN 433	BUZ 46	8
UFN 440	BUZ 45A	8

Typ	BUZ- Vergleichstyp	BUZ- Anschlußbild
UFN 441	BUZ 45A	8
UFN 442	BUZ 45A	8
UFN 443	BUZ 45A	8
UFN 450	BUZ 45B	8
UFN 451	BUZ 45B	8
UFN 452	BUZ 45B	8
UFN 453	BUZ 45B	8
UFN 520	BUZ 72A	7
UFN 521	BUZ 72A	7
UFN 522	BUZ 72A	7
UFN 523	BUZ 72A	7
UFN 530	BUZ 21	7
UFN 531	BUZ 10A	7
UFN 532	BUZ 20	7
UFN 533	BUZ 10A	7
UFN 540	BUZ 21	7
UFN 541	BUZ 21	7
UFN 542	BUZ 21	7
UFN 543	BUZ 11A	7
UFN 620	BUZ 73A	7
UFN 621	BUZ 73A	7
UFN 622	BUZ 73A	7
UFN 623	BUZ 73A	7
UFN 630	BUZ 32	7
UFN 631	BUZ 32	7
UFN 632	BUZ 32	7
UFN 633	BUZ 32	7
UFN 640	BUZ 31	7
UFN 641	BUZ 31	7
UFN 642	BUZ 31	7
UFN 643	BUZ 31	7
UFN 710	BUZ 76A	7
UFN 711	BUZ 76A	7
UFN 712	BUZ 76A	7
UFN 713	BUZ 76A	7
UFN 720	BUZ 76	7
UFN 721	BUZ 76	7
UFN 722	BUZ 76A	7
UFN 723	BUZ 76A	7
UFN 730	BUZ 60	7
UFN 731	BUZ 60	7
UFN 732	BUZ 60B	7
UFN 733	BUZ 60B	7
UFN 740	BUZ 64	8
UFN 741	BUZ 64	8
UFN 742	BUZ 60	7
UFN 743	BUZ 60	7
UFN 820	BUZ 74	7
UFN 821	BUZ 74	7
UFN 822	BUZ 74A	7
UFN 823	BUZ 74A	7
UFN 830	BUZ 41A	7
UFN 831	BUZ 41A	7
UFN 832	BUZ 42	7
UFN 833	BUZ 42	7
VN 64GA	BUZ 23	8
VN 0400A	BUZ 14	8
VN 0401A	BUZ 14	8
VN 0600A	BUZ 25	8
VN 0601A	BUZ 25	8
VN 0800A	BUZ 25	8
VN 0800D	BUZ 21	7
VN 0801A	BUZ 25	8

MOS-Feldeffekttransistoren-Vergleichstabelle

Typ	BUZ - Vergleichstyp	BUZ- Anschlußbild	Typ	BUZ- Vergleichstyp	BUZ- Anschlußbild
VN 0801D	BUZ 21	7	VNM 001A	BUZ 64	8
VN 1000A	BUZ 25	8	VNN 002A	BUZ 45	8
VN 1000D	BUZ 21	7	VNP 002A	BUZ 45	8
VN 1001A	BUZ 25	8	2 SK 294	BUZ 72A	7
VN 1001D	BUZ 20	7	2 SK 295	BUZ 72A	7
VN 3500A	BUZ 64	8	2 SK 296	BUZ 76A	7
VN 3500D	BUZ 60	7	2 SK 298	BUZ 64	8
VN 3501A	BUZ 63	8	2 SK 299	BUZ 45A	8
VN 3501D	BUZ 60	7	2 SK 308	BUZ 34	8
VN 4000A	BUZ 64	8	2 SK 310	BUZ 76	7
VN 4000D	BUZ 60	7	2 SK 311	BUZ 41A	7
VN 4001A	BUZ 63	8	2 SK 319	BUZ 60	7
VN 4001D	BUZ 60	7	2 SK 320	BUZ 41A	7
VN 4501A	BUZ 45A	8	2 SK 345	BUZ 71A	7
VN 4501D	BUZ 41A	7	2 SK 346	BUZ 72A	7
VN 4502A	BUZ 44A	8	2 SK 398	BUZ 23	8
VN 4502D	BUZ 42	7	2 SK 351	BUZ 84A	8
VN 5001A	BUZ 45A	8	2 SK 382	BUZ 42	7
VN 5001D	BUZ 41A	7	2 SK 383	BUZ 72	7
VN 5002A	BUZ 46	8	2 SK 401	BUZ 64	8
VN 5002D	BUZ 42	7	(2 SK 411)	(BUZ 84A)	8
VNL 001A	BUZ 64	8	2 SK 428	BUZ 72	7
			(2 SK 440)	(BUZ 73)	7

BUZ-Anschlußbelegung

Abb. 1



Abb. 6



Abb. 2

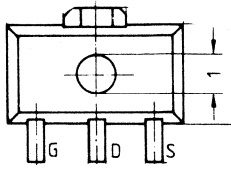

Abb. 7

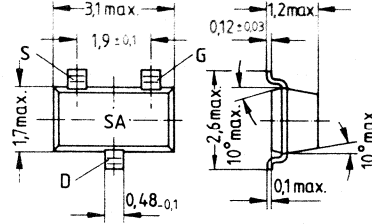

Abb. 3

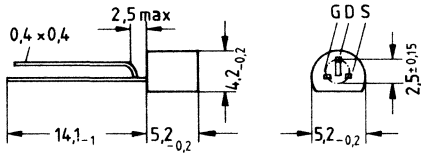

Abb. 8

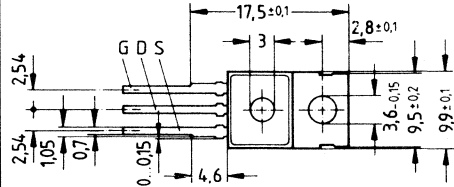

Abb. 4

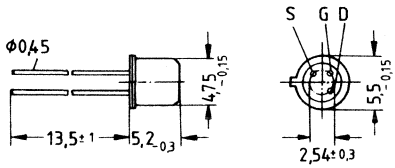

Abb. 9

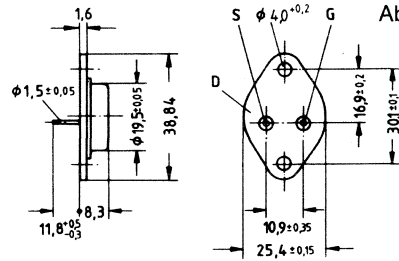

Abb. 5

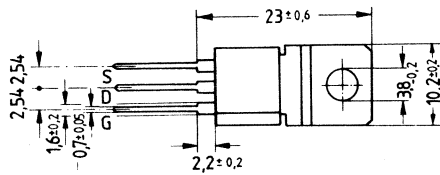

Abb. 10

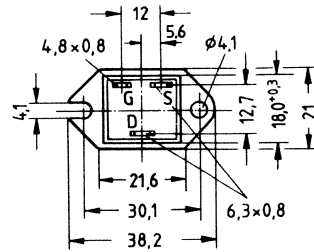

Anschlußbelegungen von Transistoren

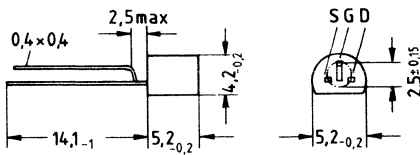
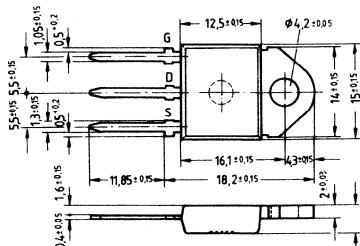
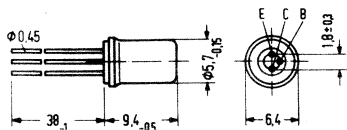

**AC 121; AC 151; AC 152
ASY 48; ASY 70**

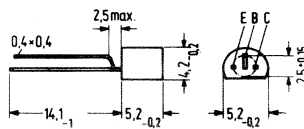

**BC 182; BC 183; BC 212;
BC 237...BC 239**

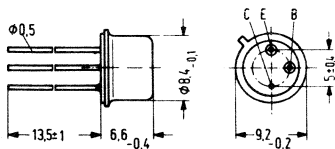

**BC 140; BC 160
BC 141; BC 161**

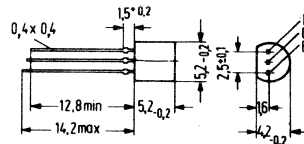

BC 257...BC 259

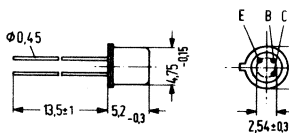

BC 107...BC 109 A, B, C

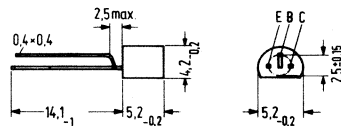

**BC 307...BC 309;
BC 327; BC 328;
BC 337; BC 338**

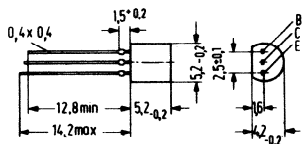

BC 167...BC 169

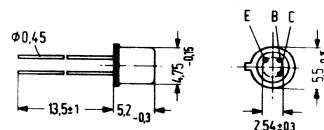

BC 368; BC 369

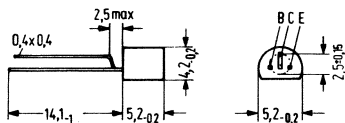

BC 177...BC 179

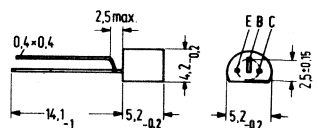

**BC 413...BC 416; BC 516; BC 517;
BC 546...BC 560**

Anschlußbelegungen von Transistoren

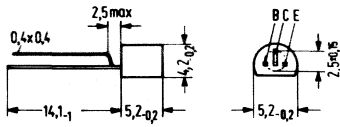

**BC 635...BC 640
BC 875...BC 880**

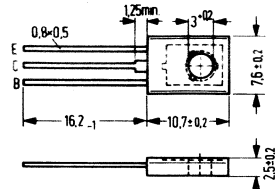

**BD 135...BD 140; BD 287;
BD 288; BD 433...BD 436**

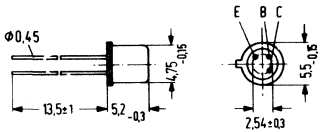

**BCX 22...BCX 24;
BCX 39**

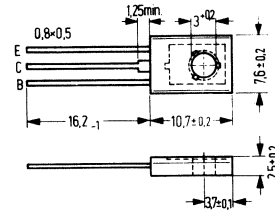

BD 437...BD 442; BD 675...BD 680

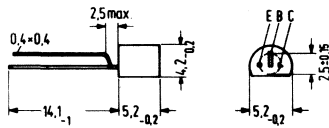

BCX 58; BCX 59

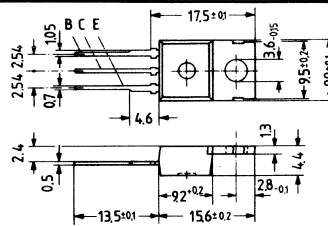

BD 533...BD 538; BD 645...BD 650

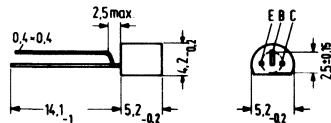

**BCX 73...BCX 76
BCX 78; BCX 79**

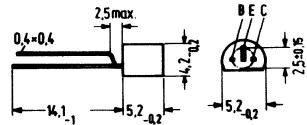

**BF 199; BF 240; BF 241;
BF 254; BF 255**

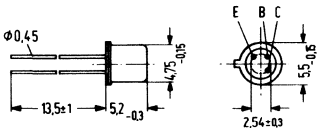

**BCY 58; BCY 59; BCY 65; BCY 67;
BCY 77; BCY 78; BCY 79**

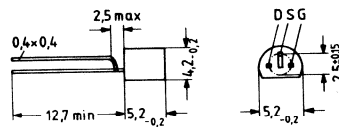

**BF 245 A, 245 B, 245 C;
BF 256 A, 256 B, 256 C;
BF 410 A, 410 B, 410 C, 410 D**

Anschlußbelegungen von Transistoren

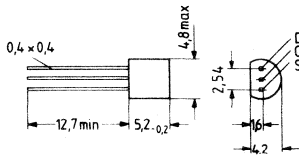

BF 246 A, 246 B, 246 C

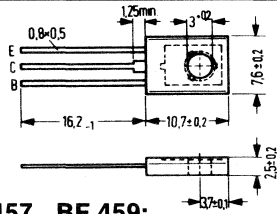

**BF 457...BF 459;
BF 469...BF 472**

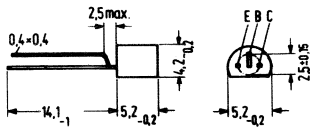

BF 324

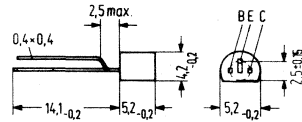

**BF 606 A;
BF 926; BF 959**

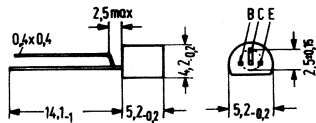

BF 420; BF 421

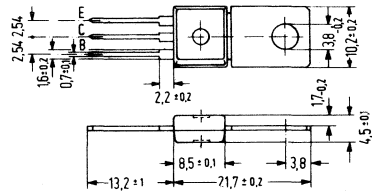

**BF 857...BF 859;
BF 869...BF 872**

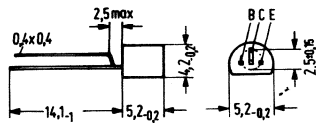

BF 422; BF 423

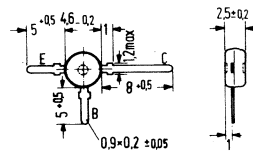

**BF 967; BF 968; BF 970;
BF 979 S**

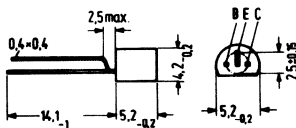

BF 450; BF 451

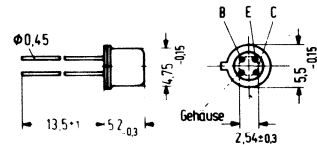

BFR 15 A; BFS 55 A

Anschlußbelegungen von Transistoren

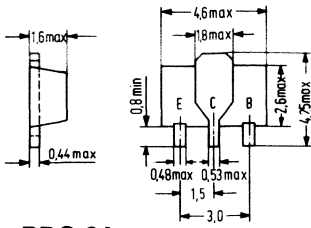

BRQ 64

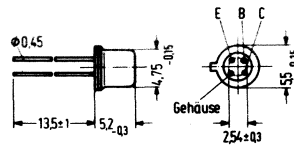

**BFW 30; BFX 59; BFX 59 F;
BFX 59 R; BFX 89; BFX 90**

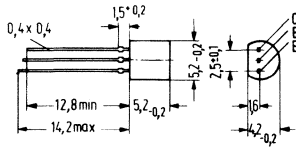

BFP 22; BFP 23

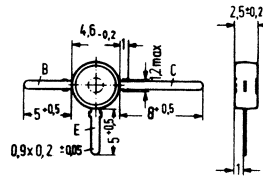

**BFW 93; BFT 97; BFT 65;
BFW 92**

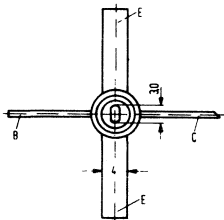

BFT 98; BFT 99

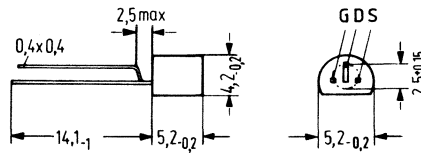

BSS 89

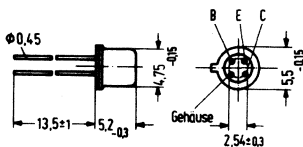

BFT 66

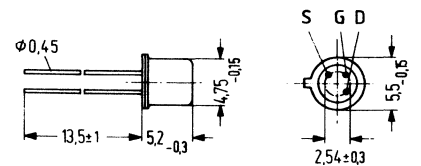

BSS 91

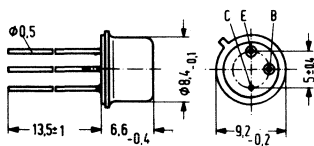

BFW 16 A; BFX 55

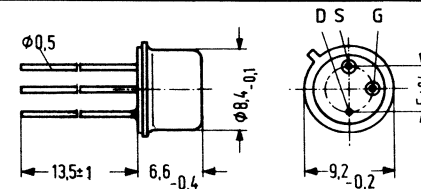

BSS 93

Anschlussbelegungen von Transistoren

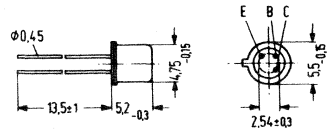
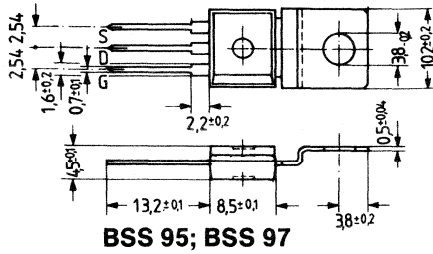

**2 N 2220; 2 N 2221; 2 N 2221 A;
2 N 2222; 2 N 2222 A;
2 N 2906; 2 N 2906 A;
2 N 2907; 2 N 2907 A**

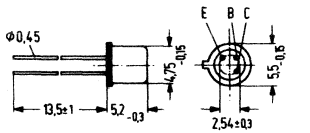

**BSX 48; BSX 49; BSY 18;
BSY 62; BSY 63**

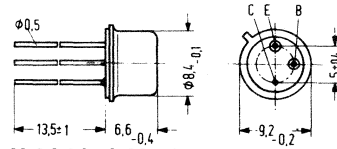

**2 N 2218; 2 N 2218 A; 2 N 2219;
2 N 2219 A; 2 N 2904; 2 N 2904 A;
2 N 2905; 2 N 2905 A; 2 N 2905 A;
2 N 3019; 2 N 4033**

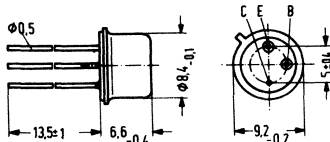

**BSV 15...BSV 17;
BSX 45...BSX 47;
BSX 62; BSX 63; BSY 34; BSY 58**

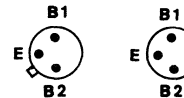

2 N 2646

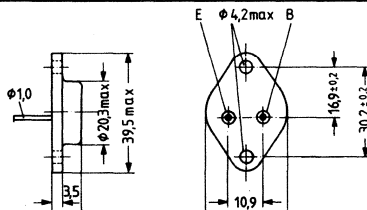

BU 205; BU 208 A; BU 326 A; BU 626 A

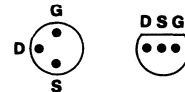

E 300 J 300

E 300 und J 300 sind gegeneinander
austauschbar (technisch gleich)

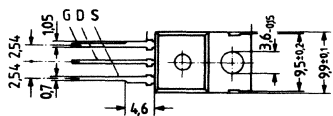

**BUZ 10; BUZ 20; BUZ 30; BUZ 32;
BUZ 41; BUZ 42; BUZ 80**

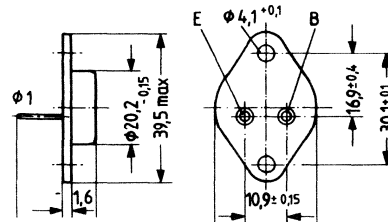

2 N 3055

Anschlußbelegungen von Thyristoren u. Triacs

Schaltbild
eines
Thyristors

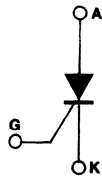

C 106 D
BST C 12
BST C 10...
S 2800
TIC 106 D
S 4006
S 4010 L
S 40..

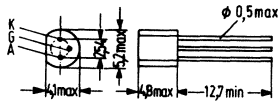

BRX 45; BRX 46; BRX 47; BR 103

Triacs

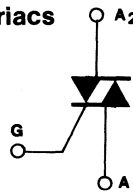

Schaltzeichen eines TRIACS

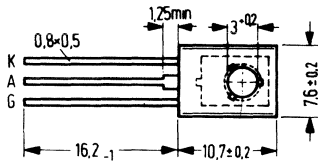

BR 303

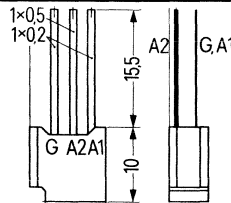

TX 30...; TX 38...

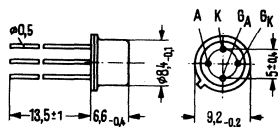

BRY 20; BRY 21

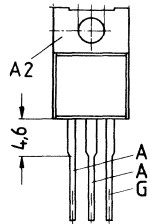

Q 4008 LT; TIC 226;
TX C 18; TX C 10...;
TXD 10...TXC 90;
TIC 201 D; Q 4000 L;
TIC 206 M

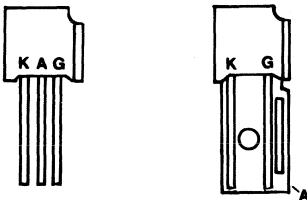

BST A 3026 M; BST C 30...BTS C 31;

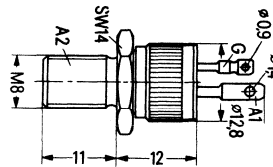

TXD 90...; TXD 98...; TXE 99..

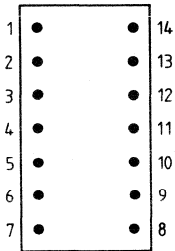

gemeinsame Anoden

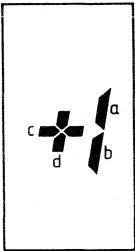

DL-701

- 1 gemeinsame Anode cd
- 2 frei
- 3 frei
- 4 frei
- 5 frei
- 6 frei
- 7 Kathode d
- 8 Kathode c
- 9 frei
- 10 Kathode b
- 11 Kathode a
- 12 frei
- 13 frei
- 14 gemeinsame Anode ab

DL 701

DL 701, rot, gem. Anode ±, Dezimalpunkt rechts, Segmentstrom 30 mA, Durchlaßspannung (IF = 20 mA, UF 1,7 V)

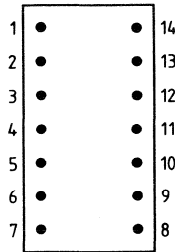

gemeinsame Kathode

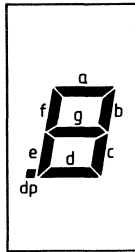

DL-702

- 1 Anode f
- 2 Anode g
- 3 Anode e
- 4 Kathode dp
- 5 frei
- 6 Anode dp
- 7 Anode d
- 8 Anode c
- 9 frei
- 10 frei
- 11 frei
- 12 gemeinsame Kathode
- 13 Anode b
- 14 Anode e

DL 702

DL 702, rot, gem. Anode 0 bis 9, Dezimalpunkt links, Segmentstrom 30 mA, Durchlaßspannung (IF = 20 mA, UF 1,7 V)

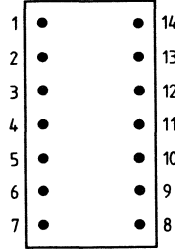

gemeinsame Kathode

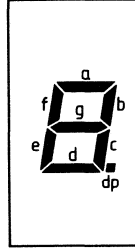

DL-704

- 1 Anode f
- 2 Anode g
- 3 frei
- 4 gemeinsame Kathode
- 5 frei
- 6 Anode e
- 7 Anode d
- 8 Anode c
- 9 Anode dp
- 10 frei
- 11 frei
- 12 gemeinsame Kathode
- 13 Anode b
- 14 Anode a

DL 704 / DL 304

DL 704, rot, gem. Kathode 0 bis 9, Dezimalpunkt rechts, Segmentstrom 30 mA, Durchlaßspannung (IF = 20 mA, UF 1,7 V) DL 704 entspricht: DL 304, MAN 74 A

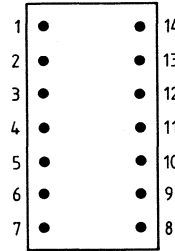

gemeinsame Anoden

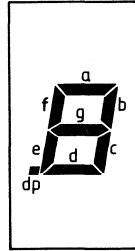

DL-707

- 1 Kathode a
- 2 Kathode f
- 3 gemeinsame Anode
- 4 frei
- 5 frei
- 6 Kathode dp
- 7 Kathode e
- 8 Kathode d
- 9 gemeinsame Anode
- 10 Kathode c
- 11 Kathode g
- 12 frei
- 13 Kathode b
- 14 gemeinsame Anode

DL 707 / DL 307

DL 707, rot, gem. Anode 0 bis 9, Dezimalpunkt links, Segmentstrom 30 mA, Durchlaßspannung (IF = 20 mA, UF 1,7 V) DL 707 entspricht: DL 307, XAN 72, MAN 72, jedoch Pin 9 nicht belegt.

DL 707 R

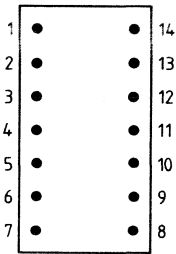

gemeinsame Anoden

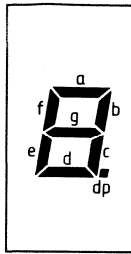

- 1 Kathode a
- 2 Kathode f
- 3 gemeinsame Anode
- 4 frei
- 5 frei
- 6 Kathode dp
- 7 Kathode e
- 8 Kathode d
- 9 gemeinsame Anode
- 10 Kathode c
- 11 Kathode g
- 12 frei
- 13 Kathode b
- 14 gemeinsame Anode

DL 707 R, rot, gem. Anode 0 bis 9, Dezimalpunkt rechts, Segmentstrom 30 mA, Durchlaßspannung (IF = 20 mA, UF 1,7 V)

DL 721/722

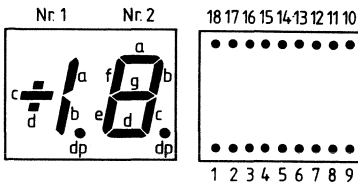

DL 721, LED-Anzeige, 12,7 mm Symbolhöhe, 2stellig, gem. Anode ± 0 bis 19, Dezimalpunkt rechts (IF = 20 mA, UF 1,7 V)

- | | |
|-------------------------|------------------------------------|
| 1 Kathode c (Nr. 1) | 1 Anode d (Nr. 1) |
| 2 Kathode d (Nr. 1) | 2 Anode c (Nr. 1) |
| 3 Kathode b (Nr. 1) | 3 Anode b (Nr. 1) |
| 4 Kathode dp (Nr. 1) | 4 Anode dp (Nr. 1) |
| 5 Kathode e (Nr. 2) | 5 Anode e (Nr. 2) |
| 6 Kathode d (Nr. 2) | 6 Anode d (Nr. 2) |
| 7 Kathode g (Nr. 2) | 7 Anode g (Nr. 2) |
| 8 Kathode c (Nr. 2) | 8 Anode c (Nr. 2) |
| 9 Kathode dp (Nr. 2) | 9 Anode dp (Nr. 2) |
| 10 Kathode b (Nr. 2) | 10 Anode b (Nr. 2) |
| 11 Kathode a (Nr. 2) | 11 Anode a (Nr. 2) |
| 12 Kathode f (Nr. 2) | 12 Anode f (Nr. 2) |
| 13 Anode Ziffer (Nr. 2) | 13 gemeinsame Kathode Nr. 2 |
| 14 Anode dp (Nr. 1) | 14 Kathode dp (Nr. 1) |
| 15 Kathode a (Nr. 1) | 15 Anode a (Nr. 1) |
| 16 Anode a, b (Nr. 1) | 16 gemeinsame Kathode a, b (Nr. 1) |
| 17 frei | 17 frei |
| 18 Anode c, d (Nr. 1) | 18 gemeinsame Kathode c, d (Nr. 1) |

DL 722 wie DL 721, jedoch gem. Kathode

DL 727/728

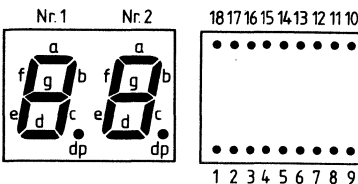

DL 727 rot, gem. Anode, 0 bis 99, Dezimalpunkt rechts, Segmentstrom (IF = 20 mA, UF 1,7 V)

DL 728 wie DL 727, jedoch gem. Kathode.

- | | |
|----------------------|-----------------------------|
| 1 e Kathode (Nr. 1) | 1 e Anode (Nr. 1) |
| 2 d Kathode (Nr. 1) | 2 d Anode (Nr. 1) |
| 3 c Kathode (Nr. 1) | 3 c Anode (Nr. 1) |
| 4 dp Kathode (Nr. 1) | 4 dp Anode (Nr. 1) |
| 5 e Kathode (Nr. 2) | 5 e Anode (Nr. 2) |
| 6 d Kathode (Nr. 2) | 6 d Anode (Nr. 2) |
| 7 g Kathode (Nr. 2) | 7 g Anode (Nr. 2) |
| 8 c Kathode (Nr. 2) | 8 c Anode (Nr. 2) |
| 9 dp Kathode (Nr. 2) | 9 dp Anode (Nr. 2) |
| 10 b Kathode (Nr. 2) | 10 b Anode (Nr. 2) |
| 11 a Kathode (Nr. 2) | 11 a Anode (Nr. 2) |
| 12 f Kathode (Nr. 2) | 12 f Anode (Nr. 2) |
| 13 Anode Nr. 2 | 13 gemeinsame Kathode Nr. 2 |
| 14 Anode Nr. 1 | 14 gemeinsame Kathode Nr. 1 |
| 15 b Kathode (Nr. 1) | 15 b Anode (Nr. 1) |
| 16 a Kathode (Nr. 1) | 16 a Anode (Nr. 1) |
| 17 g Kathode (Nr. 1) | 17 g Anode (Nr. 1) |
| 18 f Kathode (Nr. 1) | 18 f Anode (Nr. 1) |

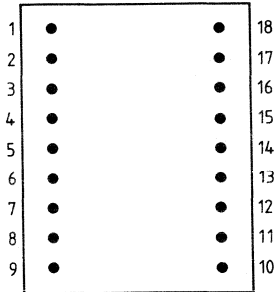
DL 746

gemeinsame Anoden

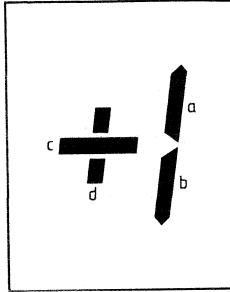

- 1 kein Stift
- 2 Kathode d
- 3 kein Stift
- 4 kein Stift
- 5 kein Stift
- 6 kein Stift
- 7 kein Stift
- 8 gemeinsame Anode c,d
- 9 kein Stift
- 10 kein Stift
- 11 Kathode b
- 12 kein Stift
- 13 kein Stift
- 14 gemeinsame Anode a, b
- 15 kein Stift
- 16 Kathode a
- 17 Kathode c
- 18 kein Stift

DL 746, LED-Anzeigen, 16 mm Symbolhöhe, 1stellig, rot, gem. Anode ± Segmentstrom (typ. $I_F = 20 \text{ mA}$, $U_F 3,4 \text{ V}$) Abm. $21 \times 8,5 \text{ mm}$

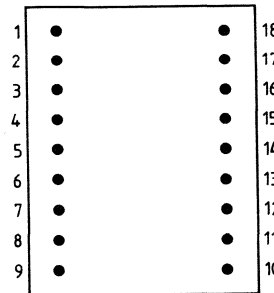
DL 747, DL 847

gemeinsame Anoden

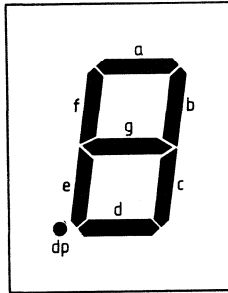

- 1 kein Stift
- 2 Kathode a
- 3 Kathode f
- 4 gemeinsame Anode
- 5 Kathode e
- 6 gemeinsame Anode
- 7 Kathode dp
- 8 kein Stift
- 9 kein Stift
- 10 kein Stift
- 11 Kathode d
- 12 gemeinsame Anode
- 13 Kathode c
- 14 Kathode g
- 15 Kathode b
- 16 kein Stift
- 17 gemeinsame Anode
- 18 kein Stift

DL 747, Anzeige, 16 mm Symbolhöhe, 1stellig, rot, gem. Anode 0 bis 9, Dezimalpunkt links, Segmentstrom (typ. $I_F = 20 \text{ mA}$, $U_F 3,4 \text{ V}$) DL = 20 mm Symbolhöhe

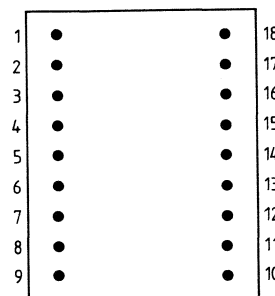
DL 749

gemeinsame Kathoden

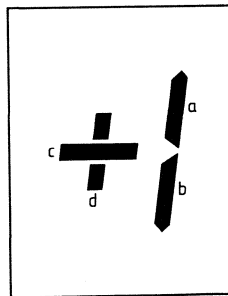

- 1 kein Stift
- 2 Anode a
- 3 kein Stift
- 4 kein Stift
- 5 kein Stift
- 6 kein Stift
- 7 kein Stift
- 8 gemeinsame Kathode c, d
- 9 kein Stift
- 10 kein Stift
- 11 Anode b
- 12 kein Stift
- 13 kein Stift
- 14 gemeinsame Kathode a, b
- 15 kein Stift
- 16 Anode a
- 17 Anode c
- 18 kein Stift

DL 749, Anzeige, 16 mm Symbolhöhe, ± gem. Kathode, Segmentstrom (typ. $I_F = 20 \text{ mA}$, $U_F 3,4 \text{ V}$)

DL 750, DL 850

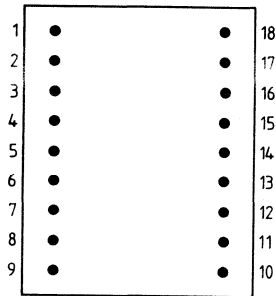

gemeinsame Kathoden

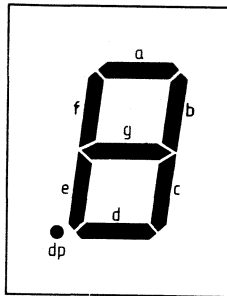

- | | |
|----|-----------------------|
| 1 | kein Stift |
| 2 | Anode a |
| 3 | Anode f |
| 4 | gemeinsame Kathode |
| 5 | Anode e |
| 6 | gemeinsame Kathode |
| 7 | Anode Dezimalpunkt dp |
| 8 | kein Stift |
| 9 | kein Stift |
| 10 | kein Stift |
| 11 | Anode d |
| 12 | gemeinsame Kathode |
| 13 | Anode c |
| 14 | Anode g |
| 15 | Anode b |
| 16 | kein Stift |
| 17 | gemeinsame Kathode |
| 18 | kein Stift |

DL 750, Anzeige, 16 mm Symbolhöhe, 1stellig, rot, gem. Kathode 0 bis 9, Dezimalpunkt links, Segmentstrom (typ. $I_F = 20$ mA, $U_F 3,4$ V)
DL 850 = 20 mm Symbolhöhe

DL 3400, DL 3405

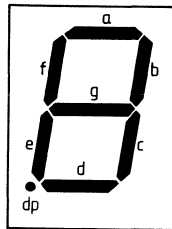
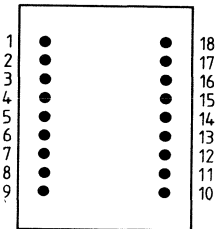

- | | | | |
|----|------------|----|------------|
| 1 | kein Stift | 1 | kein Stift |
| 2 | Kathode a | 2 | Anode a |
| 3 | Kathode f | 3 | Anode f |
| 4 | Anode | 4 | Kathode |
| 5 | Kathode e | 5 | Anode e |
| 6 | Anode | 6 | Kathode dp |
| 7 | Kathode dp | 7 | Anode |
| 8 | kein Stift | 8 | kein Stift |
| 9 | kein Stift | 9 | kein Stift |
| 10 | kein Stift | 10 | kein Stift |
| 11 | Kathode d | 11 | Anode d |
| 12 | Anode | 12 | Kathode |
| 13 | Kathode c | 13 | Anode c |
| 14 | Kathode g | 14 | Anode g |
| 15 | Kathode b | 15 | Anode b |
| 16 | kein Stift | 16 | kein Stift |
| 17 | Anode | 17 | Kathode |
| 18 | kein Stift | 18 | kein Stift |

DL 3400, LED-Anzeige, 20 mm Symbolhöhe, 1stellig, gem. Anode 0 bis 9, Dezimalpunkt links, Segmentstrom 50 mA (typ. $I_F = 20$ mA, $U_F 1,6$ V)
DL 3405 wie DL 3400, jedoch gem. Kathode

DL 3401/3403

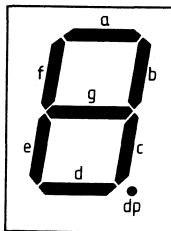
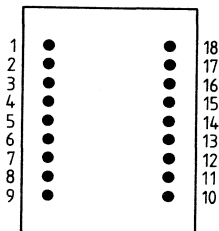

- | | | | |
|----|------------|----|------------|
| 1 | kein Stift | 1 | kein Stift |
| 2 | Kathode a | 2 | Anode a |
| 3 | Kathode f | 3 | Anode f |
| 4 | Anode | 4 | Kathode |
| 5 | Kathode e | 5 | Anode e |
| 6 | Anode | 6 | Kathode |
| 7 | frei | 7 | frei |
| 8 | kein Stift | 8 | kein Stift |
| 9 | kein Stift | 9 | kein Stift |
| 10 | Kathode dp | 10 | Anode dp |
| 11 | Kathode d | 11 | Anode d |
| 12 | Anode | 12 | Kathode |
| 13 | Kathode c | 13 | Anode c |
| 14 | Kathode g | 14 | Anode g |
| 15 | Kathode b | 15 | Anode b |
| 16 | kein Stift | 16 | kein Stift |
| 17 | Anode | 17 | Kathode |
| 18 | kein Stift | 18 | kein Stift |

DL 3401, LED-Anzeige, 20 mm Symbolhöhe, 1stellig, gem. Anode 0 bis 9, Dezimalpunkt rechts, Segmentstrom 50 mA (typ. $I_F = 20$ mA, $U_F 1,6$ V)
DL 3403 wie DL 3401, jedoch gem. Kathode

DL 3406

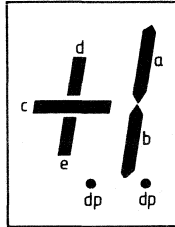
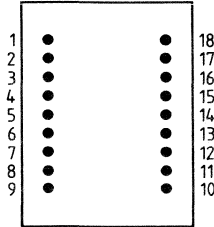

- | | | | |
|----|------------|----|------------|
| 1 | kein Stift | 14 | Anode c |
| 2 | Kathode a | 15 | Anode a |
| 3 | Anode d | 16 | kein Stift |
| 4 | Kathode d | 17 | Kathode a |
| 5 | Kathode c | 18 | kein Stift |
| 6 | Kathode e | | |
| 7 | Anode e | | |
| 8 | Kathode dp | | |
| 9 | kein Stift | | |
| 10 | Anode dp | | |
| 11 | Kathode dp | | |
| 12 | Kathode b | | |
| 13 | Anode b | | |

DL 3406, LED-Anzeige, 20 mm ± 1 Dezimalpunkt rechts, Polarität, Anode und Kathode der Segmente einzeln herausgeführt. Segmentstrom 50 mA (typ. IF = 20 mA, UF 1,6 V). Abm. 27,7 × 19,8 mm.

FND 350, FND 357, FND 360, FND 367

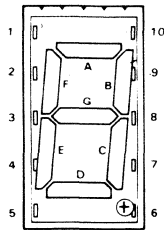

- | PIN FND 357/367 | | FND 350/360 | |
|-----------------|--------------|--------------|--|
| 1 | Gem. Kathode | Gem. Anode | |
| 2 | Segment F | Segment F | |
| 3 | Segment G | Segment G | |
| 4 | Segment E | Segment E | |
| 5 | Segment D | Segment D | |
| 6 | Gem. Kathode | Gem. Anode | |
| 7 | Dezimalpunkt | Dezimalpunkt | |
| 8 | Segment C | Segment C | |
| 9 | Segment B | Segment B | |
| 10 | Segment A | Segment A | |

Display rot, Lichtstärke (mcd)

FND 357 gem. Kathode 450 mcd
FND 367 gem. Kathode 900 mcd

FND 350 gem. Anode 450 mcd
FND 360 gem. Anode 900 mcd

FND 358, FND 368

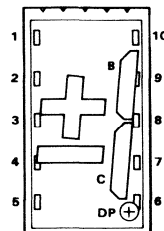

- Pinbelegung**
- | | |
|----|--------------|
| 1 | Gem. Kathode |
| 2 | Pluszeichen |
| 3 | Minuszeichen |
| 4 | N.C. |
| 5 | Nicht belegt |
| 6 | Gem. Kathode |
| 7 | Dezimalpunkt |
| 8 | Segment C |
| 9 | Segment B |
| 10 | N.C. |

Display rot

FND 358, Lichtstärke 450 mcd
FND 368, Lichtstärke 900 mcd

FND 500, FND 507, FND 560, FND 567

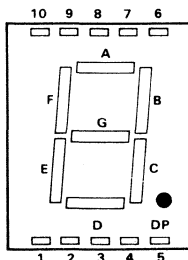

- | PIN FND 507/567 | | FND 500/560 | |
|-----------------|--------------|--------------|--|
| 1 | Segment E | Segment E | |
| 2 | Segment D | Segment D | |
| 3 | Gem. Anode | Gem. Kathode | |
| 4 | Segment C | Segment C | |
| 5 | Dezimalpunkt | Dezimalpunkt | |
| 6 | Segment B | Segment B | |
| 7 | Segment A | Segment A | |
| 8 | Gem. Anode | Gem. Kathode | |
| 9 | Segment F | Segment F | |
| 10 | Segment G | Segment G | |

Display rot, Lichtstärke (mcd)

FND 500 gem. Kathode 600 mcd
FND 507 gem. Anode 600 mcd
FND 560 gem. Kathode 1200 mcd
FND 567 gem. Anode 1200 mcd

FND 501, FND 508, FND 561, FND 568

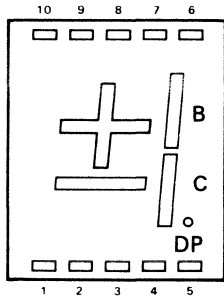

PIN FND 501/561	FND 508/568
1 Minus	Minus
2 Kathode ±	Anode ±
3 Segment C	Segment C
4 Kathode 1/DP	Anode 1/DP
5 Dezimalpunkt	Dezimalpunkt
6 Segment B	Segment B
7 Kathode 1/DP	Anode 1/DP
8 Kathode ±	Anode ±
9 Plus	Plus
10 N.C.	N.C.

Display, rot,	Lichtstärke
FND 501 gem. Kathode	600 mcd
FND 508 gem. Anode	600 mcd
FND 561 gem. Kathode	1200 mcd
FND 568 gem. Anode	1200 mcd

FND 530, FND 537, FND 540, FND 547, FND 550, FND 557

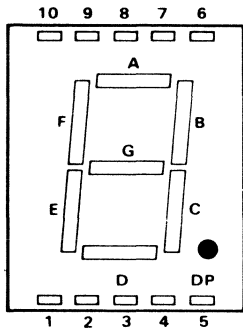

PIN FND 530/540/550	FND 537/547/557
1 Segment E	Segment E
2 Segment D	Segment D
3 Gem. Kathode	Gem. Anode
4 Segment C	Segment C
5 Dezimalpunkt	Dezimalpunkt
6 Segment B	Segment B
7 Segment A	Segment A
8 Gem. Kathode	Gem. Anode
9 Segment F	Segment F
10 Segment G	Segment G

Display, Farbe	Lichtstärke
FND 530 grün gem. Kathode	2000 mcd
FND 537 grün gem. Anode	2000 mcd
FND 540 gelb gem. Kathode	2000 mcd
FND 547 gelb gem. Anode	2000 mcd
FND 550 or. gem. Kathode	2000 mcd
FND 557 or. gem. Anode	2000 mcd

FND 531, FND 538, FND 541, FND 548, FND 551, FND 558

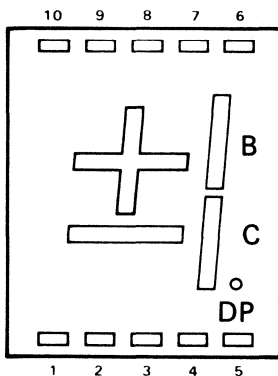

PIN FND 531	FND 538
FND 541	FND 548
FND 551	FND 558
1 Minus	Minus
2 Kathode ±	Anode ±
3 Segment C	Segment C
4 Kathode 1/D.P.	Anode 1/D.P.
5 D.P.	D.P.
6 Segment B	Segment B
7 Kathode 1/D.P.	Anode 1/D.P.
8 Kathode +/-	Anode +/-
9 Plus	Plus
10 N.C.	N.C.

Display, Farbe,	Lichtstärke
FND 531 grün gem. Kathode	2000 mcd
FND 538 grün gem. Anode	2000 mcd
FND 541 gelb gem. Kathode	2000 mcd
FND 548 gelb gem. Anode	2000 mcd
FND 551 or. gem. Kathode	2000 mcd
FND 558 or. gem. Anode	2000 mcd

FND 800, FND 807

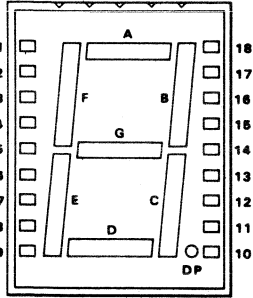

FND 800 rot, gem. Kathode 1100 mcd
FND 807 rot, gem. Anode 1100 mcd

PIN FND 800

- 1 frei
- 2 Segment A
- 3 Segment F
- 4 Gem. Kathode
- 5 Segment E
- 6 Gem. Kathode
- 7 N.C.
- 8 frei
- 9 frei
- 10 Dezimalpunkt
- 11 Segment D
- 12 Gem. Kathode
- 13 Segment C
- 14 Segment G
- 15 Segment B
- 16 frei
- 17 Gem. Kathode
- 18 frei

FND 807

- frei
- Segment A
- Segment F
- Gem. Anode
- Segment E
- Gem. Anode
- N.C
- frei
- frei
- Dezimalpunkt
- Segment D
- Gem. Anode
- Segment C
- Segment G
- Segment B
- frei
- Gem. Anode
- frei

HA 1075

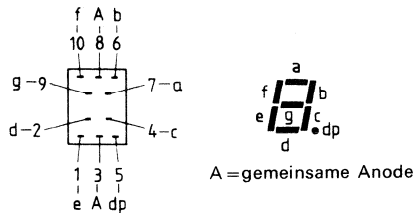

LED-Anzeige 1stellig, rot, Symbolhöhe 7 mm, gem. Anode, Dezimalpunkt rechts
Durchlaßspannung bei $I_f = 10 \text{ mA}$ 1,6...2,0 V
Segmentstrom: 10 mA

HA 1077

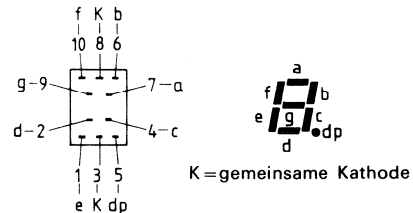

LED-Anzeige 1stellig, Symbolhöhe 7 mm, gem. Kathode, Dezimalpunkt rechts
Durchlaßspannung: 1,6 V
Segmentstrom: ca. 10...20 mA
Farbe rot

HD 1076

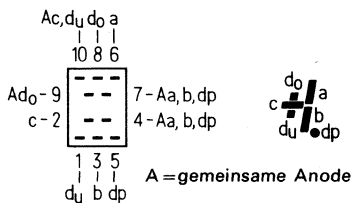

LED-Anzeige ± 1 , Symbolhöhe 7 mm, gem. Anode, Dezimalpunkt rechts, Farbe rot
Durchlaßspannung: 1,6 V
Segmentstrom: 10 mA
Farbe rot

HD 1078

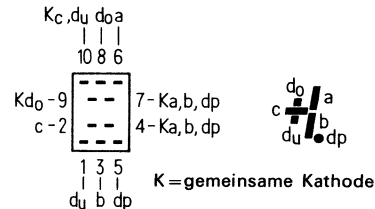

LED-Anzeige ± 1 , Symbolhöhe 7 mm, gem. Kathode, Dezimalpunkt rechts
Durchlaßspannung: 1,6 V
Segmentstrom: ca. 10...20 mA
Farbe rot

HD 1105

A = gemeinsame Anode

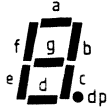
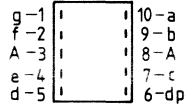

LED-Anzeige, 1stellig, Symbolhöhe 10 mm, gem. Anode, Dezimalpunkt rechts
 Durchlaßspannung: typ. 1,6 V
 Segmentstrom: 10...25 mA
 HD 1105 r = rot HD 1105 g = grün
 HD 1105 y = gb. HD 1105 o = orange

HD 1106

A = gemeinsame Anode

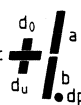
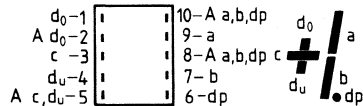

LED-Anzeige, ±, Symbolhöhe 10 mm, gemeinsame Anode, Dezimalpunkt rechts
 Durchlaßspannung: typ. 1,6 V
 Segmentstrom: 10...25 mA
 HD 1106 r = rot HD 1106 g = grün
 HD 1106 y = gb. HD 1106 o = orange

HD 1107

K = gemeinsame Kathode

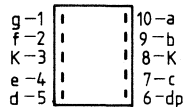

LED-Anzeige, 1stellig, Symbolhöhe 10 mm, gemeinsame Kathode, Dezimalpunkt rechts
 Durchlaßspannung: typ. 1,6 V
 Segmentstrom: ca. 10...25 mA
 HD 1107 r = rot HD 1107 g = grün
 HD 1107 y = gb. HD 1107 o = orange

HD 1108

K = gemeinsame Kathode

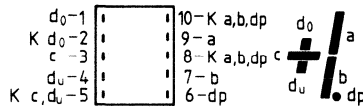

LED-Anzeige, ±, Symbolhöhe 10 mm, gemeinsame Kathode, Dezimalpunkt rechts, Durchlaßspannung: typ. 1,6 V
 Segmentstrom: ca. 10...25 mA
 HD 1108 r = rot HD 1108 g = grün
 HD 1108 y = gelb HD 1108 o = orange

HD 1111

A = gemeinsame Anode

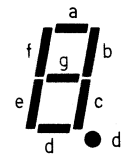
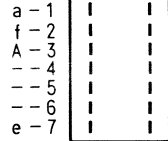

LED-Anzeige, 1stellig, Symbolhöhe 11 mm, gemeinsame Anode, Dezimalpunkt rechts
 Durchlaßspannung: 1,6 V
 Segmentstrom: ca. 10...25 mA
 HD 1111 r = rot HD 1111 g = grün
 HD 1111 y = gb. HD 1111 o = orange

HD 1112

universal

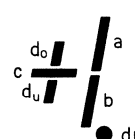
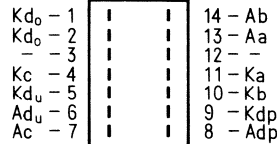

LED-Anzeige, ±, Symbolhöhe 11 mm, Dezimalpunkt rechts, Durchlaßspannung: 1,6 V
 Segmentstrom: ca. 10...25 mA
 HD 1112 r = rot HD 1112 g = grün
 HD 1112 y = g. HD 1112 o = orange

HD 1113

K = gemeinsame Kathode

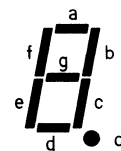
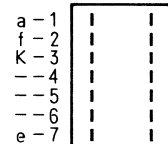

LED-Anzeige, 1stellig, Symbolhöhe 11 mm, gemeinsame Kathode, Dezimalpunkt rechts, Durchlaßspannung: typ. 1,6 V
 Segmentstrom: ca. 10...25 mA
 HD 1113 r = rot HD 1113 g = grün
 HD 1113 y = gb. HD 1113 o = orange

HD 1115

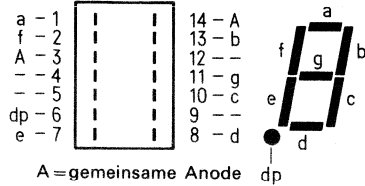

LED-Anzeige, 1stellig, Symbolhöhe 11 mm, gemeinsame Anode, Dezimalpunkt links

Durchlaßspannung: typ. 1,6 V
Segmentstrom: ca. 10...25 mA

HD 1115 r = rot HD 1115 g = grün
HD 1115 y = gb. HD 1115 o = orange

HD 1131

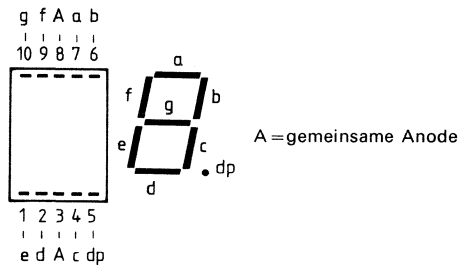

LED-Anzeige, 1stellig, Symbolhöhe 13,5 mm, gemeinsame Anode, Dezimalpunkt rechts

Durchlaßspannung: ca. 1,6 V
Segmentstrom: ca. 10...35 mA

HD 1131 r = rot = TIL 701 = DL 507
HD 1131 y = gelb = TIL 713
HD 1131 g = grün = TIL 717
HD 1131 o = orange + TIL 705

HD 1132

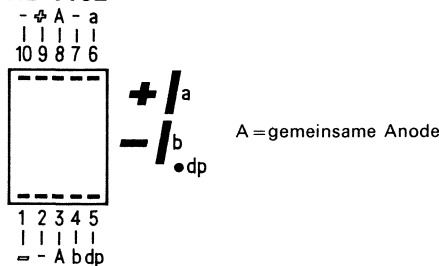

Fortsetzung nächste Spalte

LED-Anzeige ±, Symbolhöhe 13,5 mm, gemeinsame Anode, Dezimalpunkt rechts

Durchlaßspannung: ca. 1,6 V
Segmentstrom: ca. 10...35 mA

HD 1132 r = rot = TIL 703
HD 1132 y = gelb = TIL 715
HD 1132 g = grün = TIL 719
HD 1132 o = orange = TIL 707

HD 1133

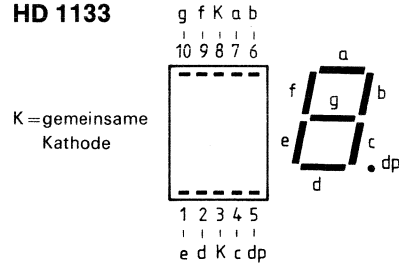

LED-Anzeige, 1stellig, Symbolhöhe 13,5 mm, gemeinsame Kathode, Dezimalpunkt rechts

Durchlaßspannung: ca. 1,6 V
Segmentstrom: ca. 10...35 mA

HD 1133 r = rot = TIL 702 = DL 500
HD 1133 y = gelb = TIL 714
HD 1133 g = grün = TIL 718
HD 1133 o = orange = TIL 706

HD 1134

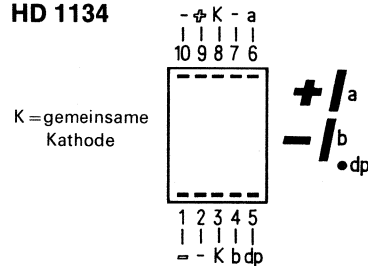

LED-Anzeige ±, Symbolhöhe 13,5 mm, gemeinsame Kathode, Dezimalpunkt rechts

Durchlaßspannung: ca. 1,6 V
Segmentstrom: ca. 10...35 mA

HD 1134 r = rot = TIL 704
HD 1134 y = gelb = TIL 716
HD 1134 g = grün = TIL 720
HD 1134 o = orange = TIL 708

HA 1141

A = gemeinsame Anode

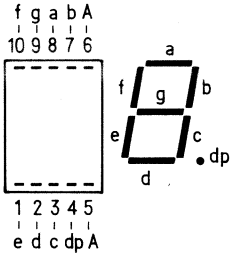

LED-Anzeige, 1stellig, Symbolhöhe 13,5 mm, gemeinsame Anode, Dezimalpunkt rechts
 Durchlaßspannung: ca. 1,6 V
 Segmentstrom: ca. 10...35 mA
 HD 1141 r = rot HD 1141 g = grün
 HD 1141 y = gb. HD 1141 o = orange

HA 1142

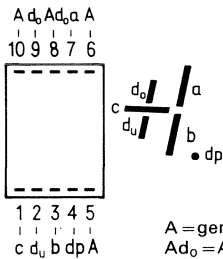

A = gemeinsame Anode
 Ad₀ = Anode d₀

LED-Anzeige, ±, Symbolhöhe 13,5 mm, gemeinsame Anode, Dezimalpunkt rechts
 Durchlaßspannung: ca. 1,6 V
 Segmentstrom: ca. 10...35 mA
 HD 1142 r = rot HD 1142 g = grün
 HD 1142 y = gb. HD 1142 o = orange

HA 1143

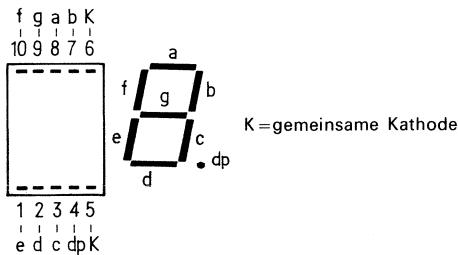

K = gemeinsame Kathode

Fortsetzung nächste Spalte

LED-Anzeige, 1stellig, Symbolhöhe 13,5 mm, gemeinsame Kathode, Dezimalpunkt rechts,
 Durchlaßspannung: typ. 1,6 V
 Segmentstrom: ca. 10...35 mA
 HA 1143 r = rot HA 1143 g = grün
 HA 1143 y = gb. HA 1143 o = orange

HA 1144

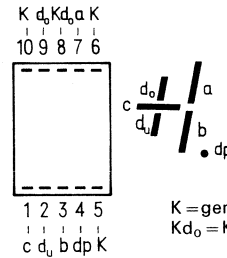

K = gemeinsame Kathode
 Kd₀ = Kathode d₀

LED-Anzeige, ±, Symbolhöhe 13,5 mm, gemeinsame Kathode, Dezimalpunkt rechts
 Durchlaßspannung: typ. 1,6 V
 Segmentstrom: ca. 10...35 mA
 HA 1144 r = rot HA 1144 g = grün
 HA 1144 y = gb. HA 1144 o = orange

HA 1181

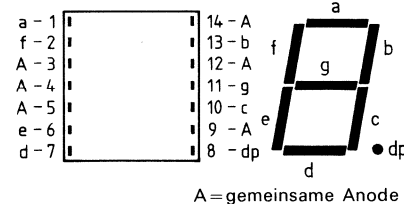

A = gemeinsame Anode

LED-Anzeige, 1stellig, Symbolhöhe 18 mm, gemeinsame Anode, Durchlaßspannung: typ. 1,6 V
 Segmentstrom: ca. 10...35 mA
 HA 1181 r = rot HA 1181 g = grün
 HA 1181 y = gb. HA 1181 o = orange

LED-Anzeigen werden immer (falls nicht ausdrücklich vermerkt) in der Draufsicht, Displayseite gezeigt, d. h. das Bauelement in Einbaulage.

HA 1182

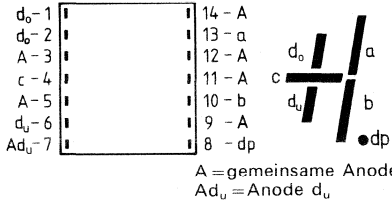

LED-Anzeige, ±, Symbolhöhe 18 mm, gemeinsame Anode, Dezimalpunkt rechts,

Durchlaßspannung: ca. 1,6 V
Segmentstrom: ca. 10...35 mA
HA 1182 r = rot HA 1182 g = grün
HA 1182 y = gb. HA 1182 o = orange

HA 1183

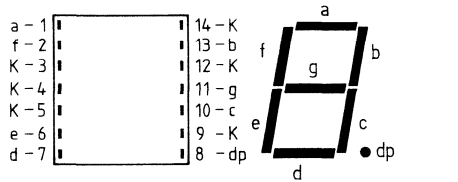

LED-Anzeige, 1stellig, Symbolhöhe 18 mm, gemeinsame Kathode, Dezimalpunkt rechts

Durchlaßspannung: ca. 1,6 V
Segmentstrom: ca. 10...35 mA
HA 1183 r = rot HA 1183 g = grün
HA 1183 y = gb. HA 1183 o = orange

HA 1184

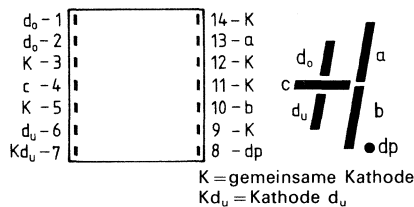

LED-Anzeige ±, Symbolhöhe 18 mm, gemeinsame Kathode, Dezimalpunkt rechts, Durchlaßspannung: ca. 1,6 V

Segmentstrom: ca. 10...35 mA
HA 1184 r = rot HA 1184 g = grün
HA 1184 y = gb. HA 1184 o = orange

HA 2142

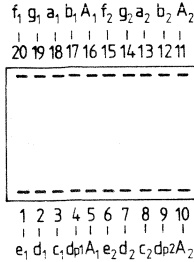

LED-Anzeige, 2stellig, gemeinsame Anode, Symbolhöhe 13,5 mm

Durchlaßspannung: ca. 1,6 V
Segmentstrom: ca. 10...35 mA
HA 2142 r = rot
HA 2142 o = orange

HA 2143

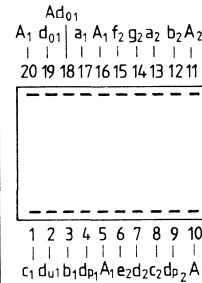

LED-Anzeige, 1½stellig, gemeinsame Anode, Symbolhöhe 13,5 mm

Durchlaßspannung: ca. 1,6 V
Segmentstrom: ca. 10...35 mA
HA 2143 r = rot
HA 2143 o = orange

HA 2144

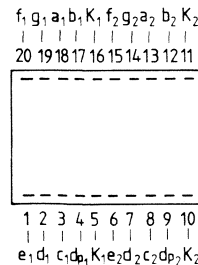

Fortsetzung nächste Spalte

LED-Anzeige, 2stellig, gemeinsame Kathode, Symbolhöhe 13,5 mm
 Durchlaßspannung: ca. 1,6 V
 Segmentstrom: ca. 10...35 mA
 HA 2144 r = rot
 HA 2144 o = orange

HD 2145

l k f g a b k
 14 13 12 11 10 9 8

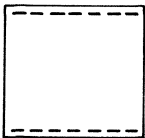

1 2 3 4 5 6 7
 k dp1 e d c dp2 K

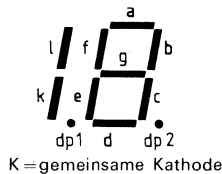

LED-Anzeige, 1½stellig, gemeinsame Kathode, Symbolhöhe 13,5 mm, für Anzeigen von 0...19
 Durchlaßspannung: ca. 1,6 V
 Segmentstrom: ca. 10...35 mA
 HD 2145 r = rot
 HD 2145 g = grün

HA 2147

K d₀₁
 K₁ d₀₁ a₁ K₁ f₂ g₂ a₂ b₂ K₂
 20 19 18 17 16 15 14 13 12 11



1 2 3 4 5 6 7 8 9 10
 c₁ d₀₁ b₁ d₀₁ K₁ e₂ d₂ c₂ d₂ K₂

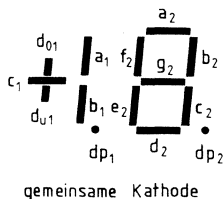

LED-Anzeige, 1½stellig, gemeinsame Kathode, Symbolhöhe 13,5 mm
 Durchlaßspannung: ca. 1,6 V
 Segmentstrom: ca. 10...35 mA
 HA 2147 r = rot
 HA 2147 o = orange

HD 14101

A = gemeinsame Anode

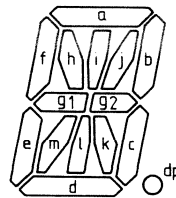

i-1	18-a
h-2	17-A
f-3	16-j
A-4	15-b
g1-5	14-g2
e-6	13-A
m-7	12-dp
d-8	11-c
l-9	10-k

Alphanumerische LED-Anzeige, 10 mm Symbolhöhe, Gehäusefarbe: grau, 14 Segmente und 1 Dezimalpunkt
 Die hier vorgestellte 14-Segment-Anzeige eignet sich zur Darstellung alphanumerischer Zeichen und Symbole.
 Der maximale Betrachtungsabstand bei dieser 10 mm hohen Anzeige beträgt 4,5 m.

Kenndaten (rot)

Lichtstärke pro Segment
 (bei I_F = 10 mA)
 (bei I_F = 25 mA)
 Durchlaßspannung bei
 (I_F = 10 mA)

typ.

I_V 300 μcd
 I_V 850 μcd
 U_F 1,6 V

MA 35 Alphanumerische Anzeige

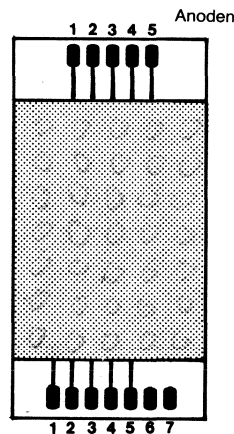

Jeder Punkt in einer Matrix bei der Anzeigeeinheit Typ MA-35 durch eine Leuchtdiode dargestellt. Dabei sind jeweils alle Kathoden einer Zeile und alle Anoden einer Spalte miteinander verbunden.

Anschlußbelegung

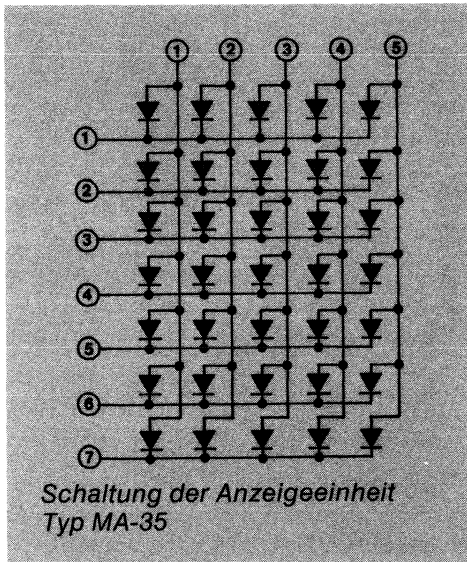

Technische Daten

Optische und elektrische Kenngrößen
pro Leuchtfeld
Lichtstärke pro Segment Typ bei
20 mA: 1,5 mcd
Wellenlänge der maximalen Emission
hellrot: 630 nm
Wellenlänge der maximalen Emission
grün: 560 nm
Durchlaßspannung
 $I_F = 20 \text{ mA Typ: } 2,7 \text{ V}$
Durchbruchspannung
 $I_R = 100 \mu\text{A: } 5 \text{ V}$
Durchlaßstrom I_F : 20 mA
Ziffernhöhe: 31 mm
Geeignet für Multiplexbetrieb
Abstrahlwinkel: 50°

5 Spalten – Anode
7 Reihen – Kathode

MAN 1, MAN 1 A

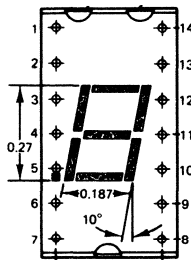

- Pin
- 1 Kathode A
 - 2 Kathode F
 - 3 Gem. Anode
 - 4 N.C.
 - 5 N.C.
 - 6 Dezimalpunkt-Kathode
 - 7 Kathode E
 - 8 Kathode D
 - 9 Gem. Anode
 - 10 Kathode C
 - 11 Kathode G
 - 12 N.C.
 - 13 Kathode B
 - 14 Gem. Anode

MAN 51 A, 71 A, 81 A, MAN 3610 A

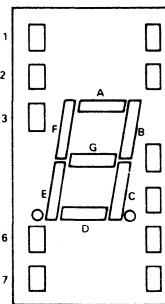

- Pin
- 1 Kathode A
 - 2 Kathode F
 - 3 Gem. Anode
 - 4 Kein Pin
 - 5 Kein Pin
 - 6 N.C.
 - 7 Kathode E
 - 8 Kathode D
 - 9 Kathode D.P.
 - 10 Kathode C
 - 11 Kathode G
 - 12 Kein Pin
 - 13 Kathode B
 - 14 Gem. Anode

MAN 51 A = gn. MAN 81 A = gelb
MAN 71 A = rot MAN 3610 = orange

MAN 10, MAN 10 A

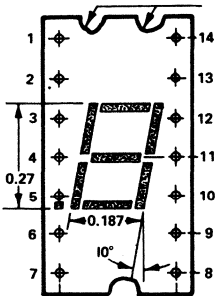

- Pin
- 1 Kathode A
 - 2 Kathode F
 - 3 Gem. Anode
 - 4 Kein Pin
 - 5 Kein Pin
 - 6 Dezimalpunkt-Kathode
 - 7 Kathode E
 - 8 Kathode D
 - 9 Gem. Anode
 - 10 Kathode C
 - 11 Kathode G
 - 12 Kein Pin
 - 13 Kathode B
 - 14 Gem. Anode

MAN 52 A, 72 A, 82 A, MAN 3620 A

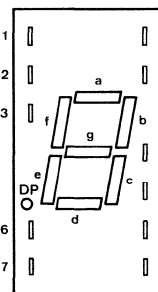

- Pin
- 1 Kathode A
 - 2 Kathode F
 - 3 Gem. Anode
 - 4 Kein Pin
 - 5 Kein Pin
 - 6 Kathode D.P.
 - 7 Kathode E
 - 8 Kathode D
 - 9 N.C.
 - 10 Kathode C
 - 11 Kathode G
 - 12 Kein Pin
 - 13 Kathode B
 - 14 Gem. Anode

MAN 52 A = gn.
MAN 72 A = rot
MAN 82 A = gelb
MAN 3620 A = orange

MAN 53 A, 73 A, 83 A, 3630 A

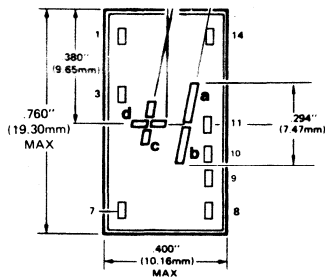

- Pin
- 1 Anode C, D
 - 2 Kein Pin
 - 3 Anode C, D
 - 4 Kein Pin
 - 5 Kein Pin
 - 6 Kein Pin
 - 7 Kathode D
 - 8 Kathode C
 - 9 N.C.
 - 10 Kathode B
 - 11 Kathode A
 - 12 Kein Pin
 - 13 Kein Pin
 - 14 Anode A, B

MAN 53 A = gn. MAN 83 A = gelb
 MAN 73 A = rot MAN 3630 A = or.

MAN 54 A, 74 A, 84 A, 3640 A

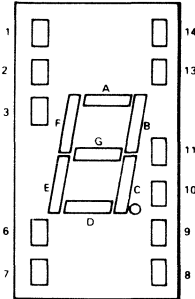

- Pin
- 1 Anode F
 - 2 Anode G
 - 3 Kein Pin
 - 4 Gem. Kathode
 - 5 Kein Pin
 - 6 Anode E
 - 7 Anode D
 - 8 Anode C
 - 9 Anode D,P.
 - 10 Kein Pin
 - 11 Kein Pin
 - 12 Gem. Kathode
 - 13 Anode B
 - 14 Anode A

MAN 54 A = gn. MAN 84 A = gelb
 MAN 74 A = rot MAN 3640 A = or.

TIL 302 rot 7 mm

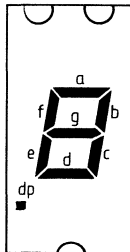
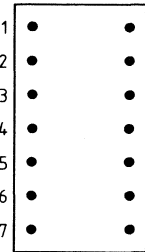

- Anschlußbelegung
 Pin
- 1 Kathode a
 - 2 Kathode f
 - 3 Anode e, f, g, dp
 - 4 -
 - 5 -
 - 6 Kathode dp, f
 - 7 Kathode e

- 8 Kathode d
 - 9 Anode c, d.
 - 10 Kathode c
 - 11 Kathode 9
 - 12 -
 - 13 Kathode b
 - 14 Anode a, b
- Dezimalpunkt links

TIL 303 rot 7 mm

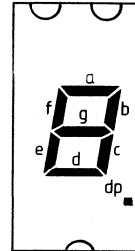
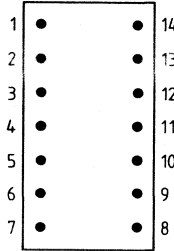

- Anschlußbelegung
 Pin
- 1 Kathode a
 - 2 Anode a, f
 - 3 Kathode f
 - 4 Kathode g
 - 5 -
 - 6 Kathode e
 - 7 Anode e, d, p

- 8 Kathode d
 - 9 Kathode c
 - 10 Kathode dp
 - 11 -
 - 12 -
 - 13 Kathode b, c, g
 - 14 Kathode b
- Dezimalpunkt rechts

TIL 304 rot 7 mm

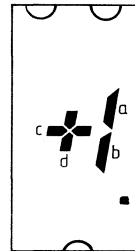
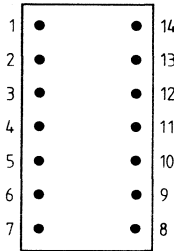

- Anschlußbelegung
 Pin
- 1 Anode c, d
 - 2 -
 - 3 -
 - 4 -
 - 5 -
 - 6 -
 - 7 Kathode d

- 8 Kathode c
 - 9 Kathode dp
 - 10 Kathode b
 - 11 Kathode a
 - 12 -
 - 13 -
 - 14 Anode a, b, dp
- Dezimalpunkt rechts

TIL 312, 314, 316, 339 8 mm

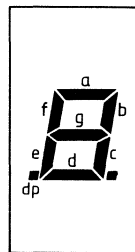
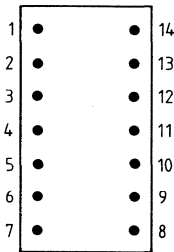

gemeinsame Anoden
 Pinbelegung nächste Seite

Pin	10 Kathode c
1 Kathode a	11 Kathode g
2 Kathode f	12 Frei
3 Gem. Anode	13 Kathode b
4 Frei	14 Gem. Anode
5 Frei	TIL 312 = rot
6 Kathode dp links	TIL 314 = grün
7 Kathode e	TIL 316 = orange
8 Kathode d	TIL 339 = gelb
9 Kathode dp rechts	

TIL 313, 315, 317, 340

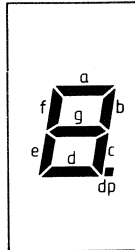
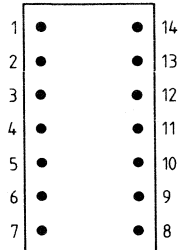

Pin	8 Kein Pin
1 Kein Pin	9 Gem. Kathode
2 Gem. Kathode	10 Anode dp
3 Anode f	11 Anode c
4 Anode g	12 Anode b
5 Anode e	13 Anode a
6 Anode d	14 Kein Pin
7 Kein Pin	TIL 317 = or.
TIL 313 = rot	TIL 340 = gelb
TIL 315 = gn.	

TIL 327, 328, 329, 341

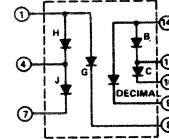
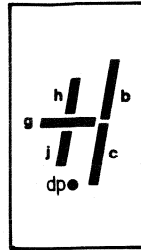

Pin	12 Kein Pin
1 Anode h, g	13 Kein Pin
4 Kathode h, Anode j	14 Anode b, dp
7 Kathode j	TIL 327 = rot
8 Kathode g	TIL 328 = grün
9 Kathode dp	TIL 329 = orange
10 Kathode c	TIL 341 = gelb
11 Anode c, Kathode B	

TIL 701 siehe HD 1131 r	TIL 713 siehe HD 1131 y
TIL 702 siehe HD 1133 r	TIL 714 siehe HD 1133 y
TIL 703 siehe HD 1132 r	TIL 715 siehe HD 1132 y
TIL 704 siehe HD 1134 r	TIL 716 siehe HD 1134 y
TIL 705 siehe HD 1131 o	TIL 717 siehe HD 1131 g
TIL 706 siehe HD 1133 o	TIL 718 siehe HD 1139 g
TIL 707 siehe HD 1132 o	TIL 719 siehe HD 1132 g
TIL 708 siehe HD 1134 o	TIL 720 siehe HD 1134 g

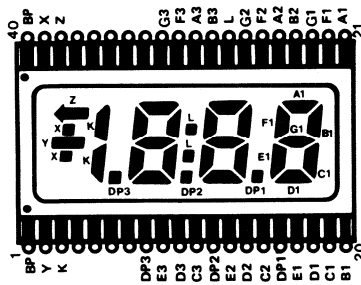

Anschlußbelegung der 3 1/2-stelligen LCD-Anzeige

D 100 PA = HD 1075 r	D 300 PK = HD 1143 r
D 100 PK = HD 1077 r	D 301 PA = HD 1141 o
D 101 PA = HD 1075 o	D 301 PK = HD 1143 o
D 101 PK = HD 1077 o	D 302 PA = HD 1141 g
D 102 PA = HD 1075 g	D 302 PK = HD 1143 g
D 102 PK = HD 1077 g	D 303 PA = HD 1141 y
D 103 PA = HD 1075 y	D 303 PK = HD 1143 y
D 103 PK = HD 1077 y	D 340 PA = HA 2142 r
D 190 PA = HD 1076 r	D 340 PK = HA 2144 r
D 190 PK = HD 1078 r	D 350 PA = HD 1131 r
D 191 PA = HD 1076 o	D 350 PK = HD 1133 r
D 191 PK = HD 1078 o	D 351 PA = HD 1131 o
D 192 PA = HD 1076 g	D 351 PK = HD 1133 o
D 192 PK = HD 1078 g	D 352 PA = HD 1131 g
D 193 PA = HD 1076 y	D 352 PK = HD 1133 g
D 193 PK = HD 1078 y	D 353 PA = HD 1131 y
D 200 PA = HD 1105 r	D 353 PK = HD 1133 y
D 200 PK = HD 1107 r	D 380 PA = HD 1134 r
D 201 PA = HD 1105 o	D 381 PA = HD 1132 o
D 201 PK = HD 1107 o	D 381 PK = HD 1134 o
D 202 PA = HD 1105 g	D 382 PA = HD 1132 g
D 202 PK = HD 1107 g	D 382 PK = HD 1134 g
D 203 PA = HD 1105 y	D 383 PA = HD 1132 y
D 203 PK = HD 1107 y	D 383 PK = HD 1134 y
D 290 PA = HD 1106 r	D 390 PA = HD 1142 r
D 290 PK = HD 1108 r	D 390 PK = HD 1144 r
D 291 PA = HD 1106 o	D 391 PA = HD 1142 o
D 291 PK = HD 1108 o	D 391 PK = HD 1144 o
D 292 PA = HD 1106 g	D 392 PA = HD 1142 g
D 292 PK = HD 1108 g	D 392 PK = HD 1144 g
D 293 PA = HD 1106 y	D 393 PA = HD 1142 y
D 293 PK = HD 1108 y	D 393 PK = HD 1144 y
D 300 PA = HD 1141 r	

Linearschaltungen

Abb. 1

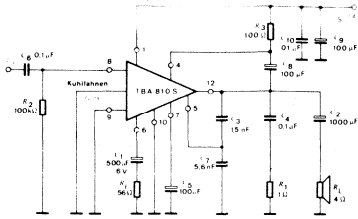

A 208 / A 210 K / 810 NF-Verstärker

Abb. 2

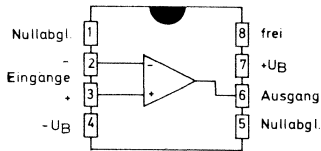

060 / 070 / 080 / 61 / 71 / 81 Breitband-OP

Abb. 3

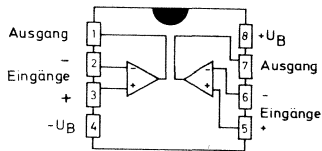

062 / 72 / 82 Doppel-OP

Abb. 4

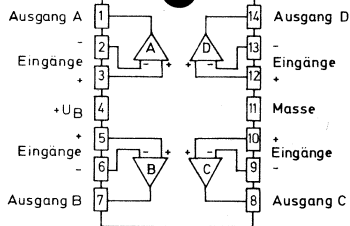

0124 / 324 / 0064 4-fach-OP

Abb. 5

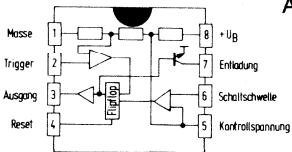

555 Univ. Zeitgeber

Abb. 6

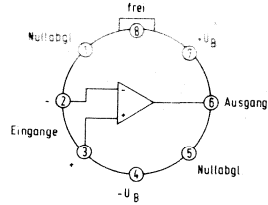

741 TO Präz.-OP

Abb. 7

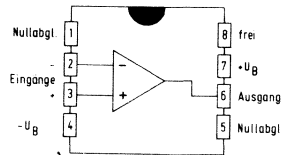

741 Dip 8 Präz.-OP

Abb. 7 a

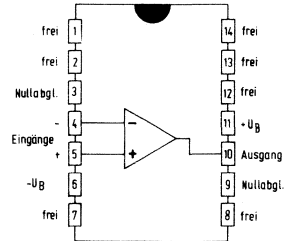

741 / 2741 Dip 14 Präz.-OP

Abb. 8

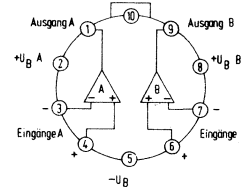

747 / 2747 2-fach-OP

Abb. 9

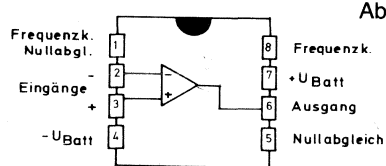

748 / 2748 Operationsverstärker

Linearschaltungen

Abb. 10

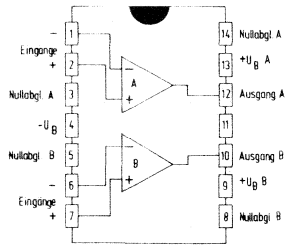

747 / 2747 DIL 14 2-fach-OP

Abb. 15

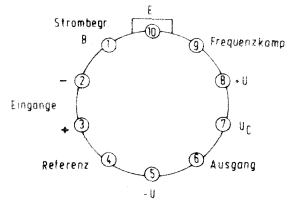

1146 / 146 Spannungsregler 2 - 77 V

Abb. 11

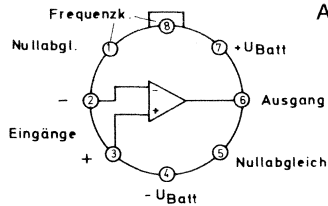

748 / 2748 TO Operationsverstärker

Abb. 16

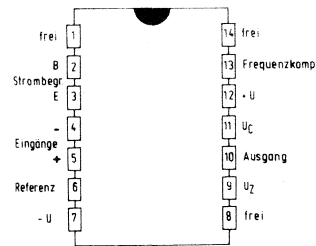

146 / 1146 Spannungsregler 2 - 77 V

Abb. 12

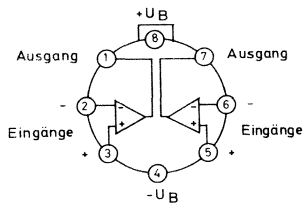

1458 / 2458 2-fach-OP

Abb. 17

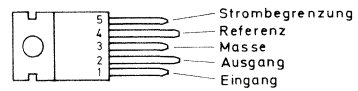

200 / 0200 Progr. Spannungsregler 2,8 - 3,6 V

Abb. 13

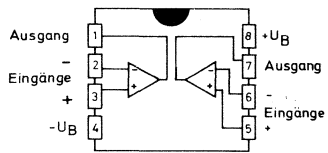

1458 / 2458 Dip 8 2-fach-OP

Abb. 18

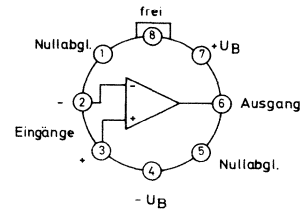

355 / 0155 Präz.-OP mit J-FET-Eingang

Abb. 14

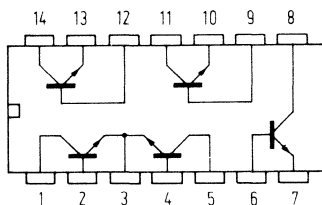

3046 / 3086 Transistor Arrays

Abb. 19

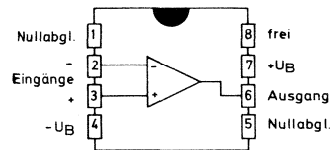

355 / 0155 Präz.-OP mit J-FET-Eingang

Linearschaltungen

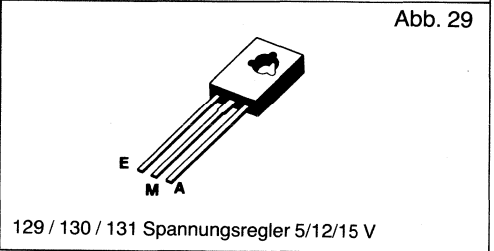
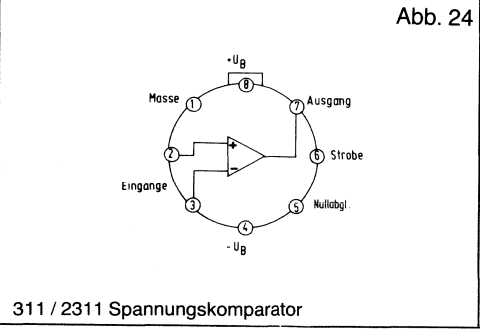
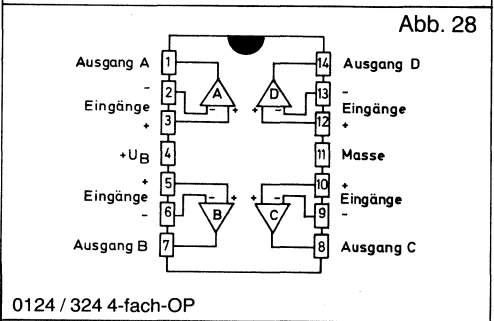
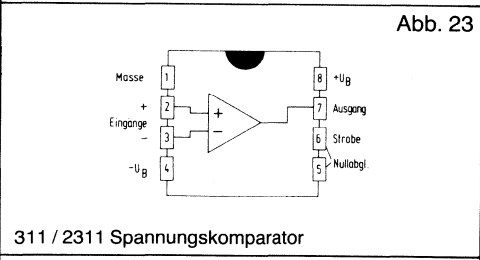
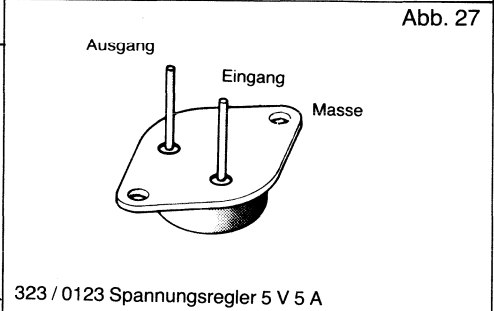
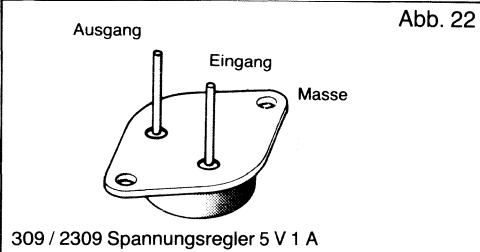
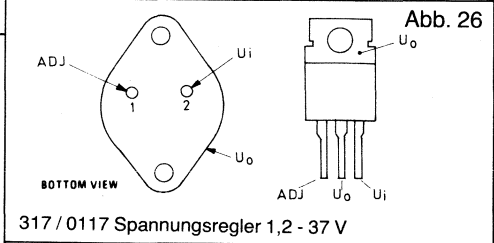
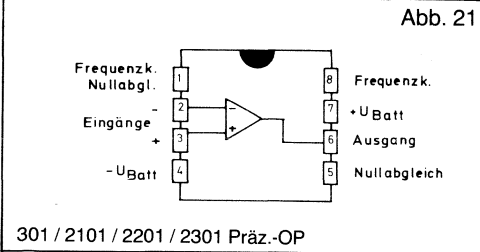
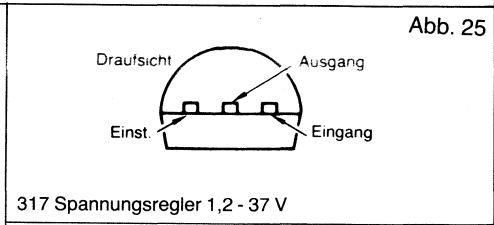
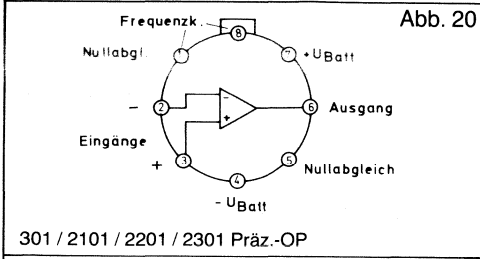

Linearschaltungen

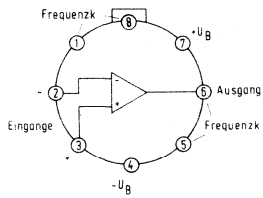

709 / 2709 A/C/M Univ.-OP

Abb. 30

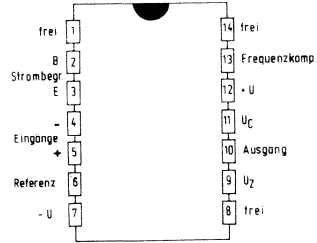

723 / 2723 Spannungsregler. 2...37 V

Abb. 35

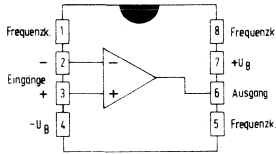

709 / 2709 DC Univ.-OP

Abb. 31

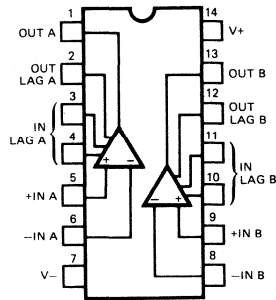

739 / 231 2-fach-OP ± 18 V

Abb. 36

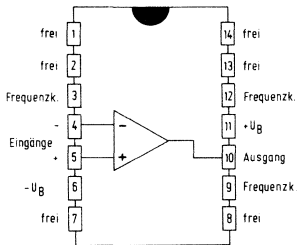

709 / 2709 AE / EC / JM Univ.-OP

Abb. 32

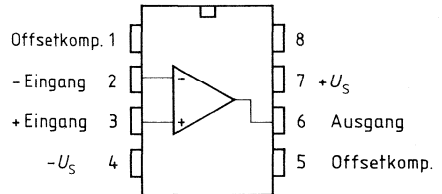

221 / 741 Dip Univ.-OP

Abb. 37

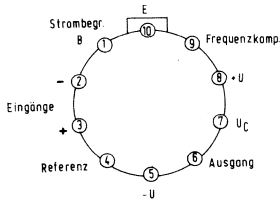

723 / 2723 Spannungsregler 2...37 V

Abb. 33

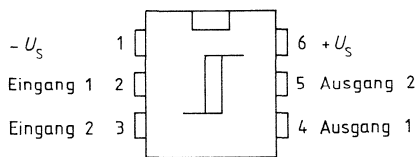

TCA 105/B Schwellenwertschalter

Abb. 34

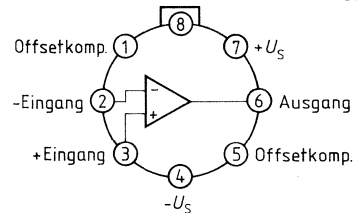

221 / 741 TO Univ.-OP

Abb. 38

Linearschaltungen

Abb. 39

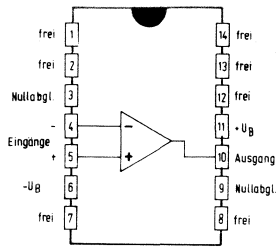

221 / 741 DIL Univ.-OP

Abb. 40

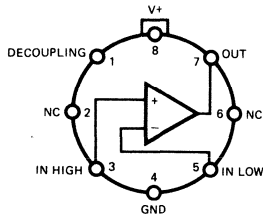

703 HF/ZF-Verstärker

Abb. 41

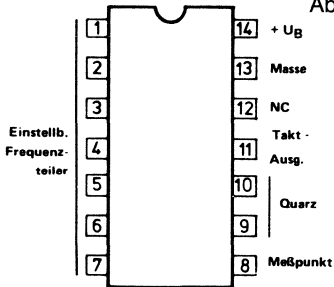

SAJ 300 T Quarzzeitbasis

Abb. 42

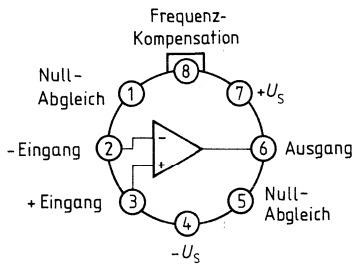

748 / 2748 TO Präz.-OP

Abb. 43

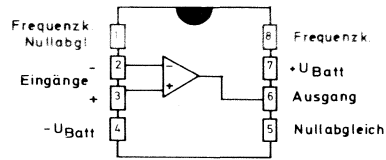

748 / 2748 Dip Präz.-OP

Abb. 44

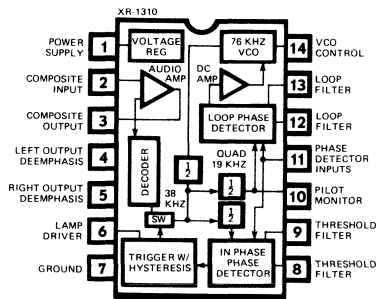

1310 Stereo-Demodulator

Abb. 45

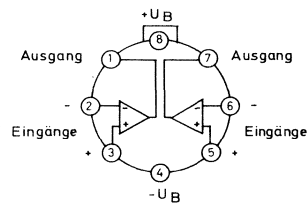

358 / 0158 Doppel-OP

Abb. 46

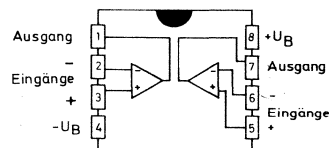

358 / 0158 Doppel-OP

Linearschaltungen

Abb. 47

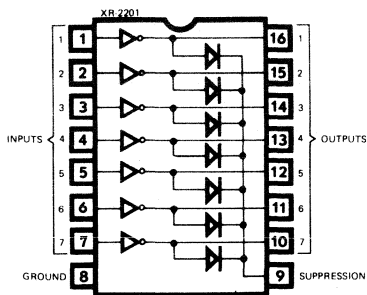

201 / 202 / 203 Darlington Transistor-Arrays

Abb. 48

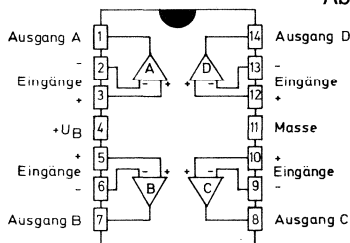

3403 / 3303 4-fach-OP

Abb. 49

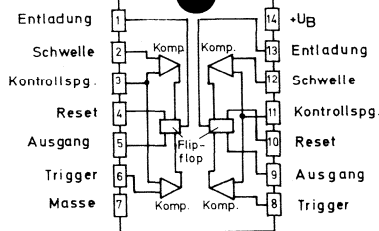

556 / 0556 Doppel-Zeitg. 2 x 555

Abb. 50

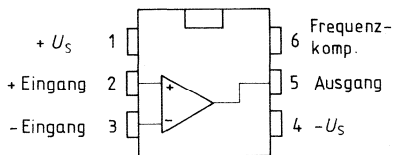

2861 / 861 Dip Univ.-OP

Abb. 51

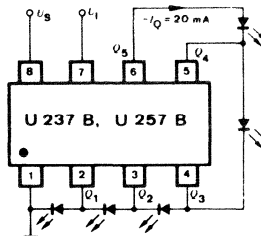

237 / 257 LED-Bandskala

Abb. 52

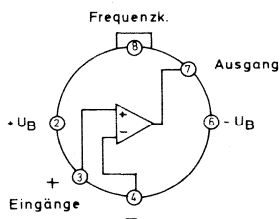

861 / 2861 TO Univ.-OP

Abb. 53

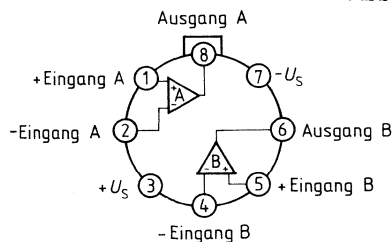

2761 / 2762 / 2765 Doppel-OP

Abb. 54

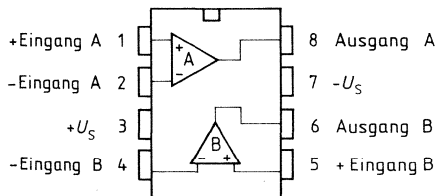

2761 / 2765 A 2-fach-OP 2 x 761

Linearschaltungen

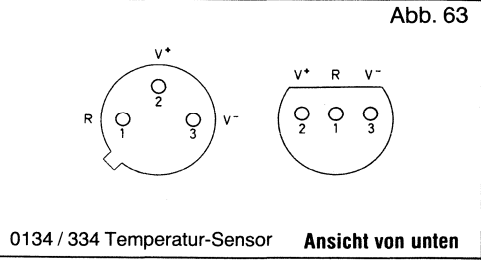
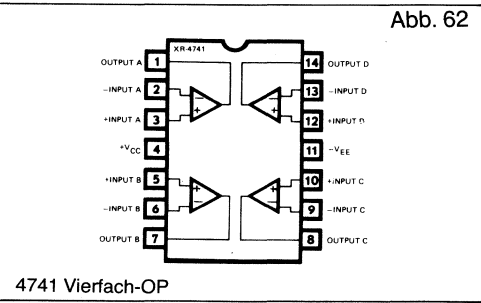
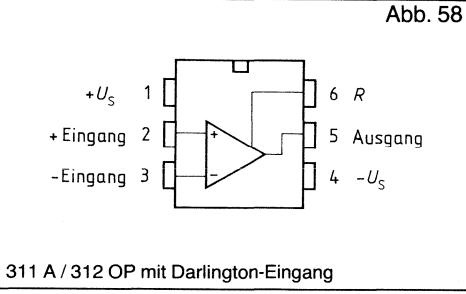
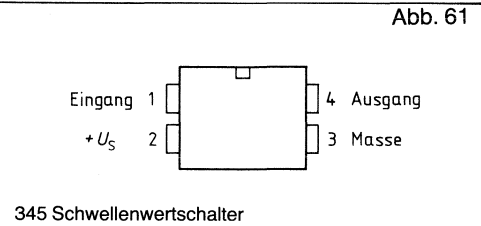
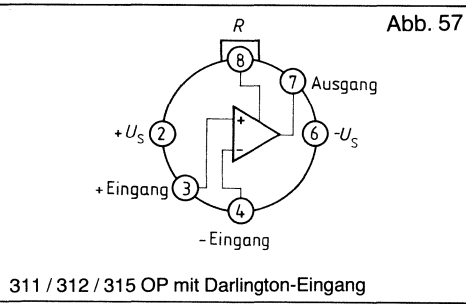
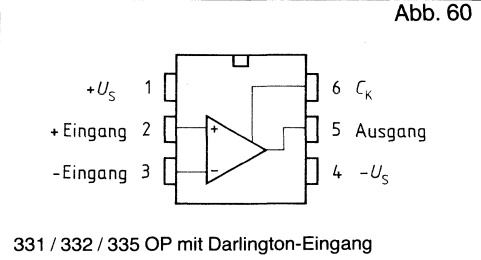
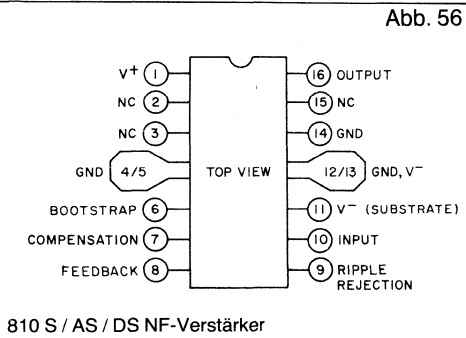
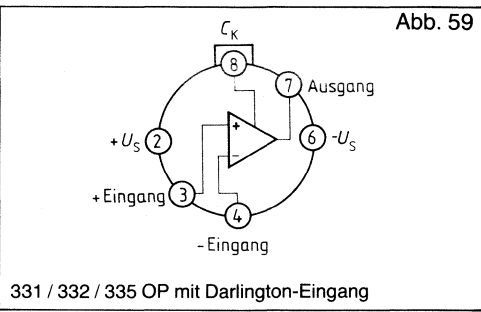
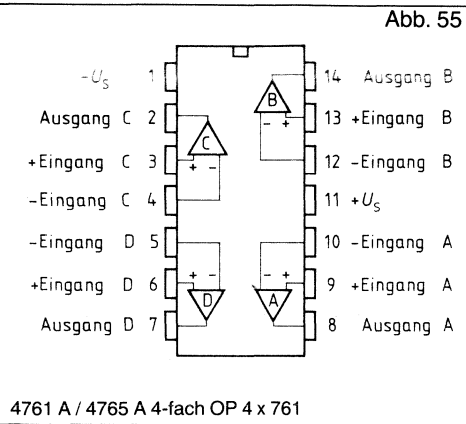

Linearschaltungen



Abb. 64

8038 Funktions-Generator

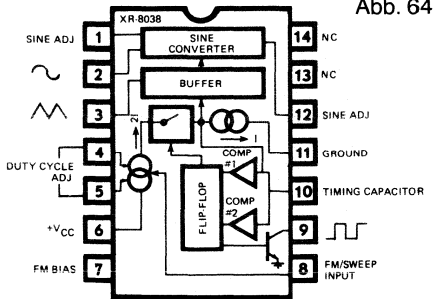

Abb. 68

139 / 239 / 339 / 2901 / MC 3302

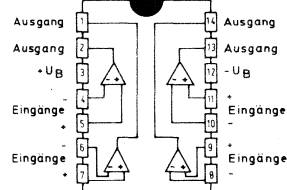

Abb. 65

074/084 4-fach-OP J-Fet-Eingang

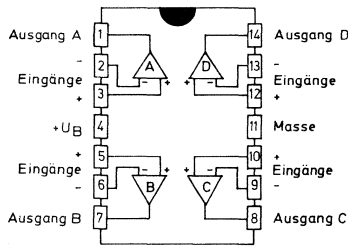

Abb. 69

7220 Codeschloß-IC

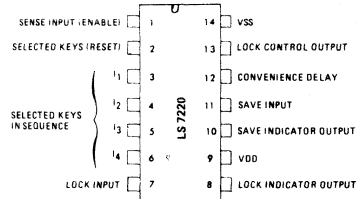

Abb. 66

0600 / 0601 / 0602 Gong-IC

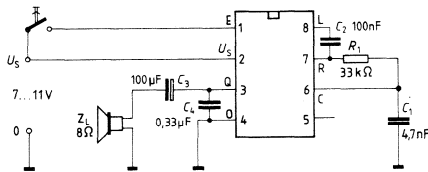

Abb. 70

MM 5314 Uhrenschaltkreis

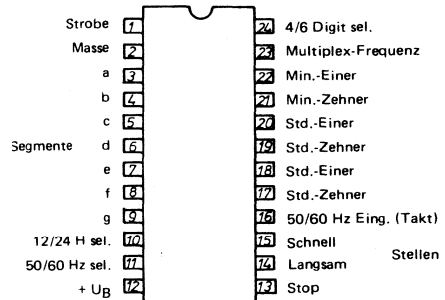

Abb. 67

1331 OP mit Darlington-Eingang

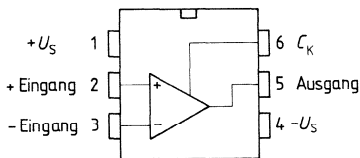

Abb. 71

TCA 965 Fensterdiskriminator

Linearschaltungen

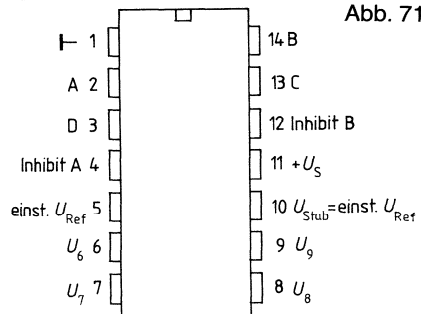
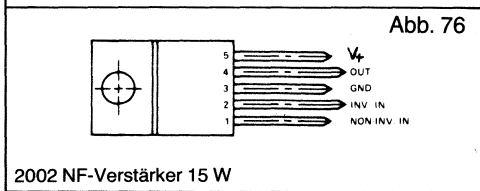
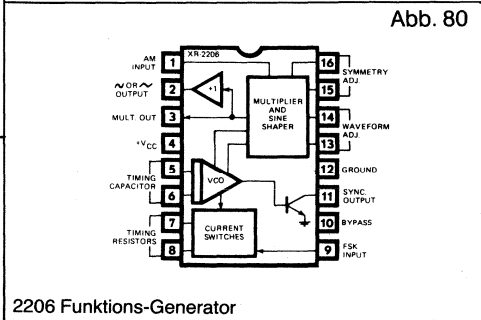
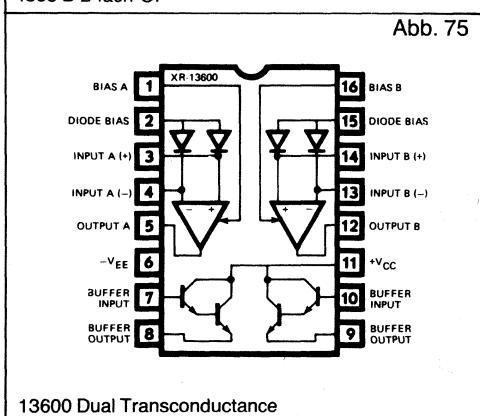
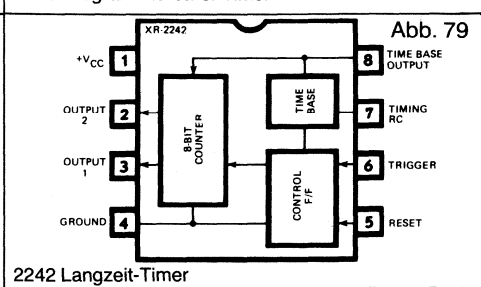
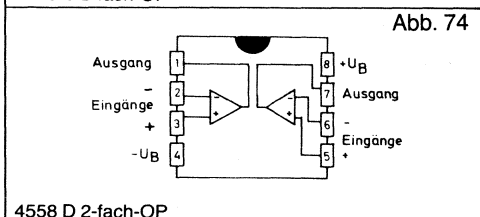
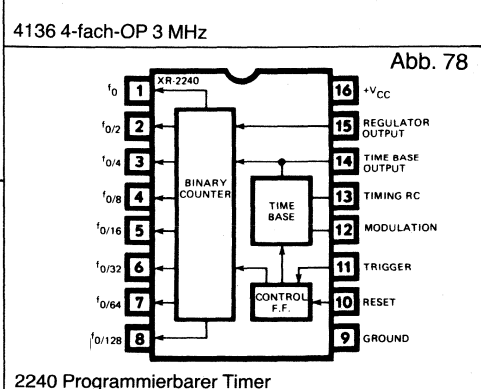
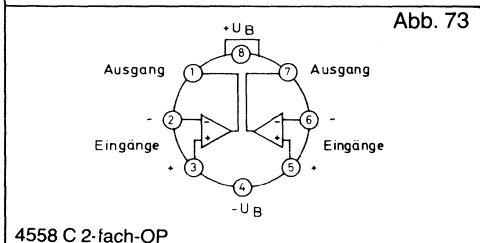
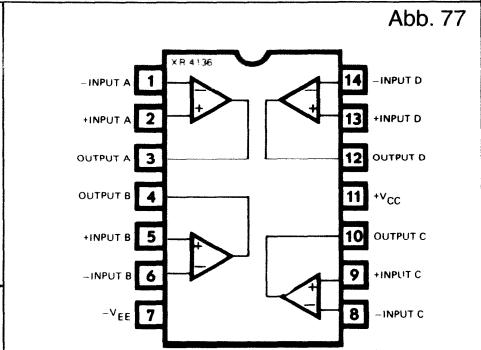
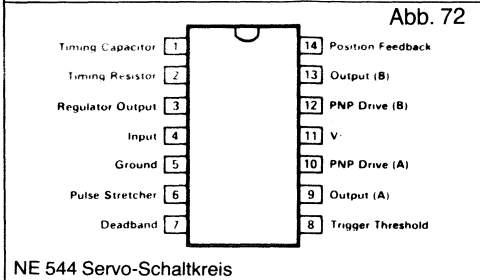

Linearschaltungen



Abb. 81

567 Ton-Decoder

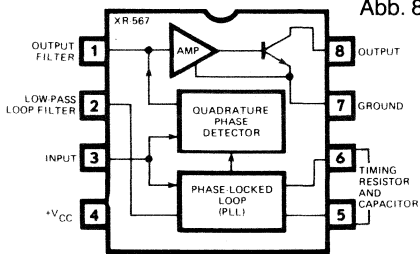

Abb. 85

S 576 A, B, C, D Sensor-Dimmer

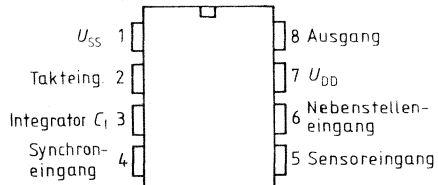

Abb. 82

2331 / 2335 2-fach-OP mit Darlington

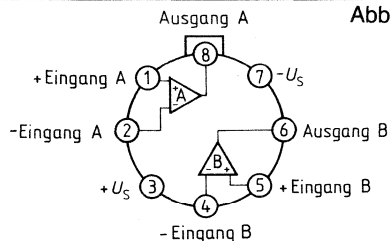

Abb. 86

SAS 241 Hall-IS

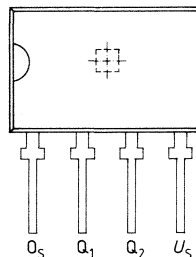

Abb. 83

2331/2332/2335 2-fach-OP mit Darlington

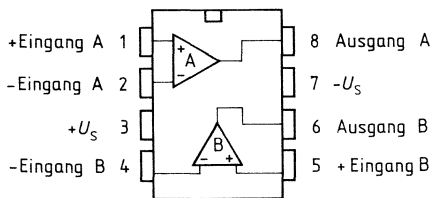

Abb. 87

TCA 365 Leistungs-OP max. 3 A

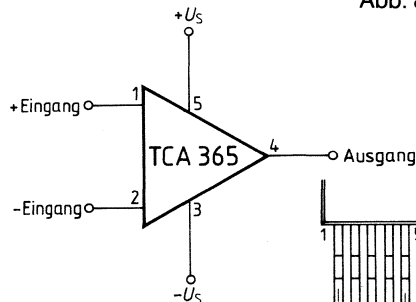

Abb. 84

SAJ 141 Teiler 1000/100/10 : 1

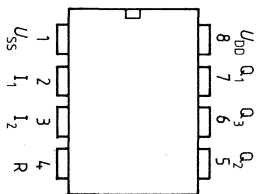

Abb. 84 a

3911 Temperatur-Sensor

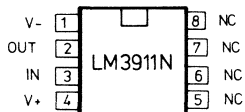

Abb. 88

0146 Programmierbarer 4-fach-OP

Linearschaltungen

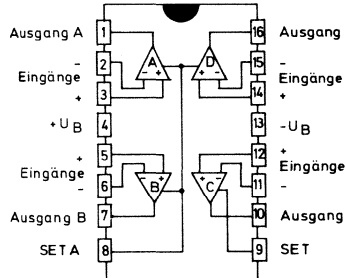
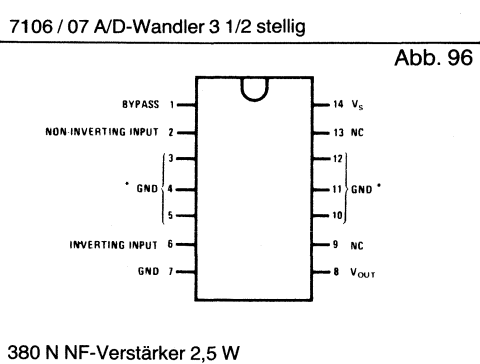
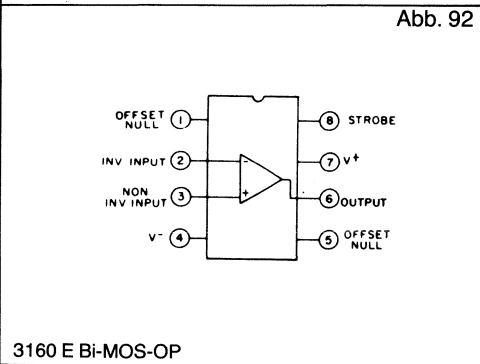
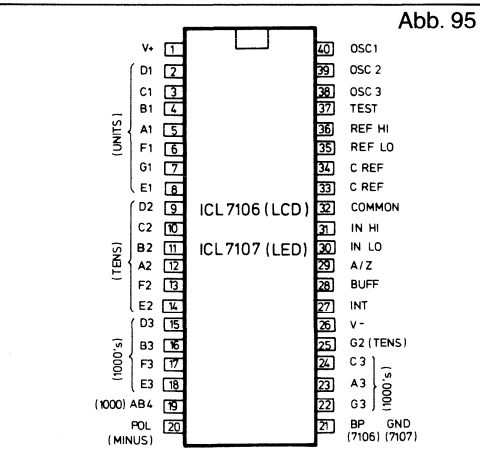
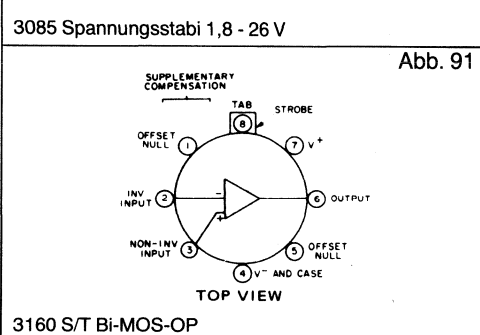
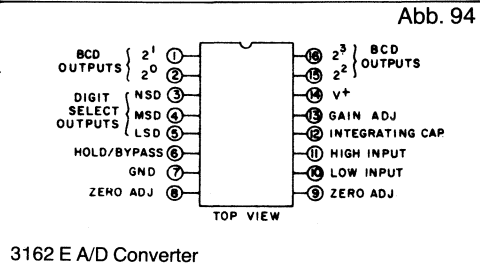
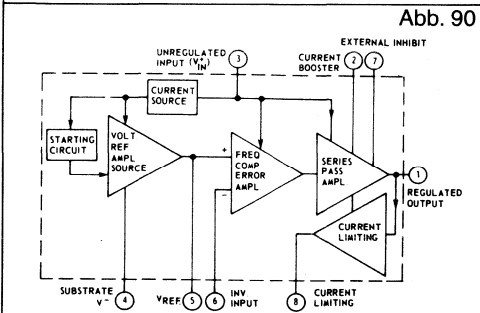
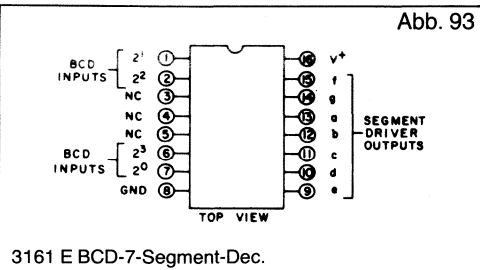
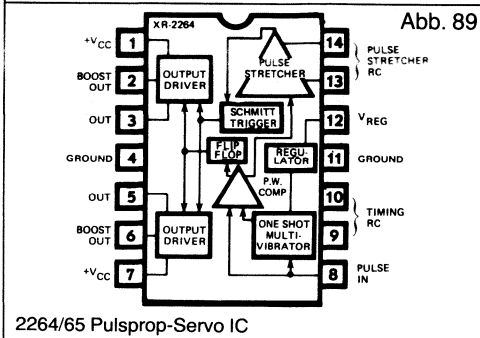

Linearschaltungen

Abb. 97

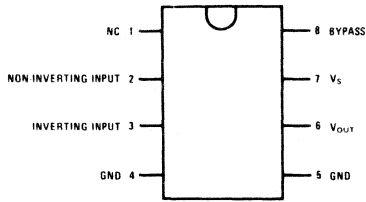

380-N 8 NF-Verstärker 2,5 W

Abb. 101

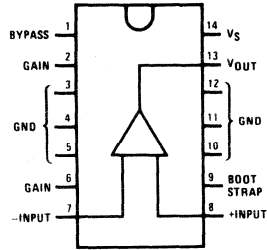

390 NF-Verstärker 1 W

Abb. 98

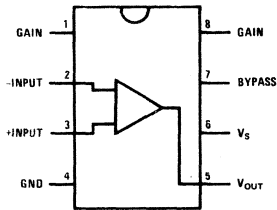

386 NF-Verstärker

Abb. 102

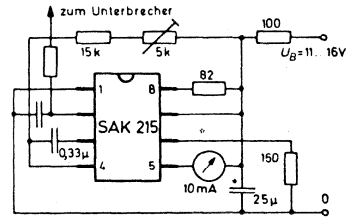

215 Impulsformer für Drehzahlmesser

Abb. 99

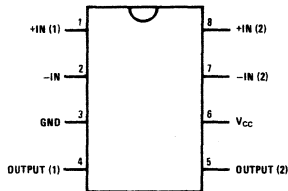

387 Rauscharmer Dual-Verstärker

Abb. 103

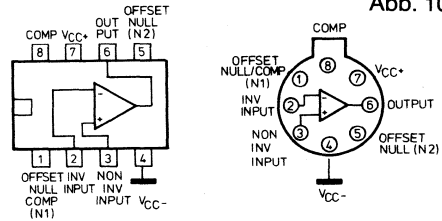

080 OP mit J-Fet Eingang

Abb. 100

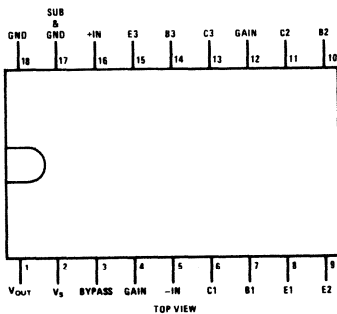

389 N Audio-Verstärker

Abb. 104

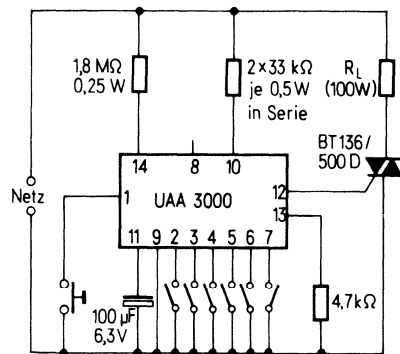

3000 Netz-Timer

Linearschaltungen

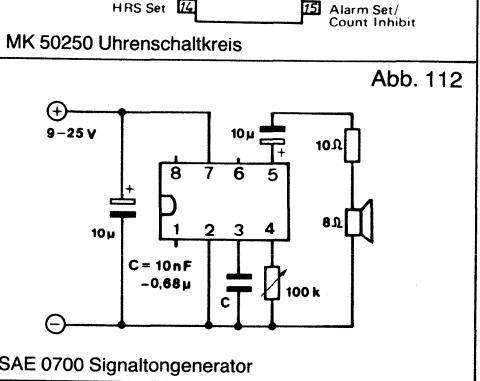
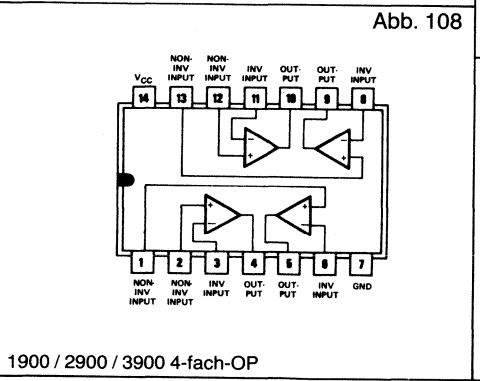
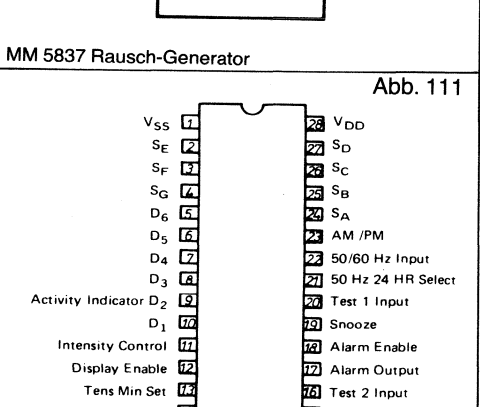
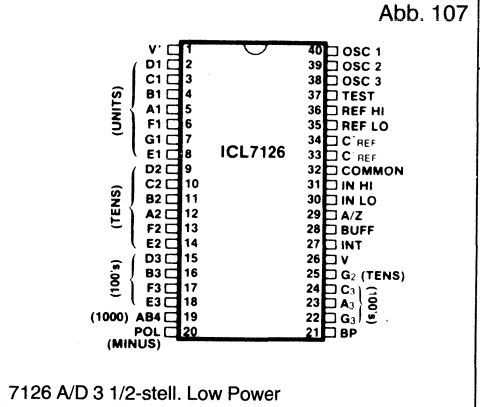
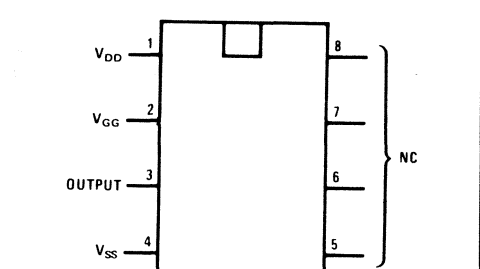
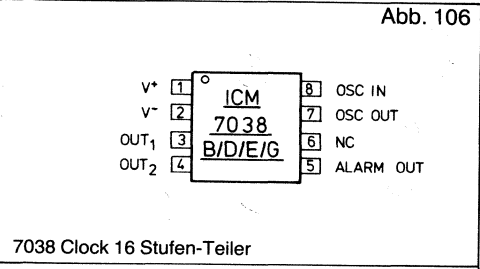
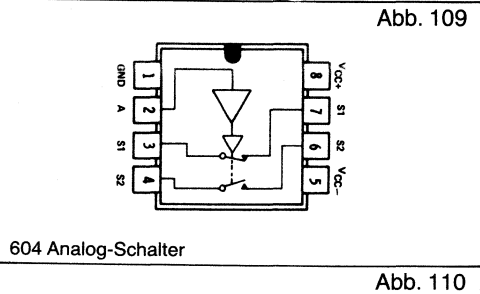
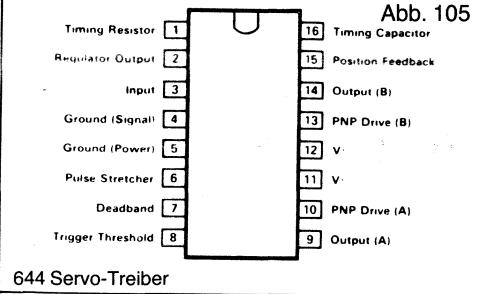

Linearschaltungen

Abb. 113

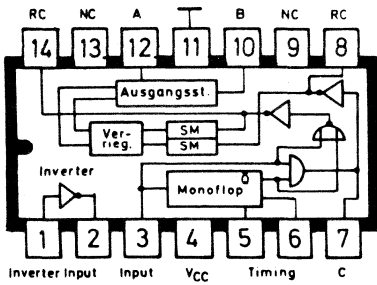

SN 28654 N Servo-Treiber

Abb. 114

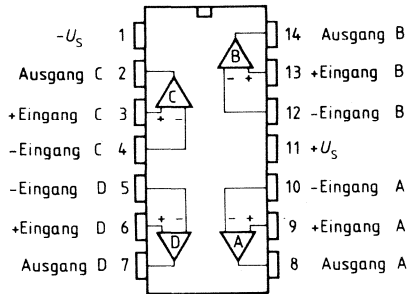

4762 A, 6765 A Vierfach-OP O.K.

Abb. 115

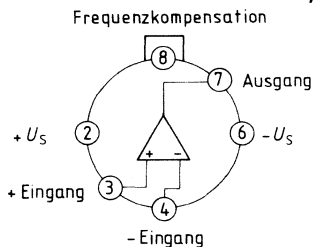

762 Einfach-OP $\pm 1,5$ bis ± 18 V

Abb. 116

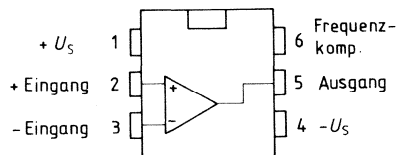

762 A, 765 A Einfach-OP O.K.

Abb. 117

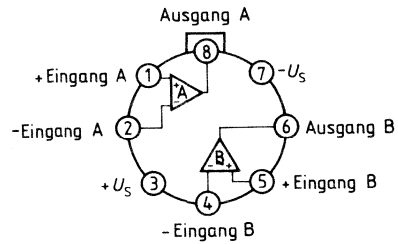

2762 Zweifach-OP

Abb. 118

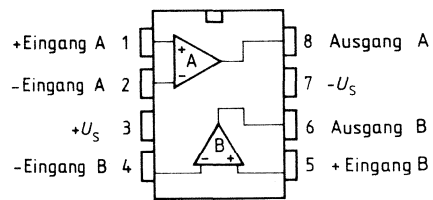

2762 A, 2765 A Zweifach-OP

Abb. 119

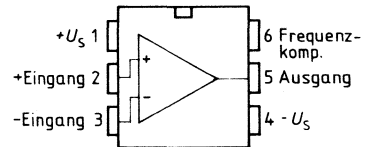

1453 A, G Einfach-OP

Abb. 120

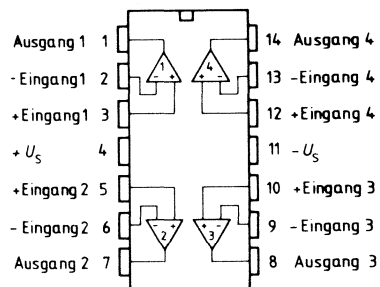

4453 A Vierfach-OP PNP

Linearschaltungen

Abb. 121

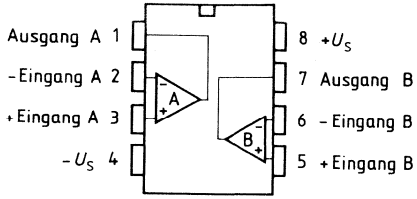

2453 A Doppel-PNP-OP

Abb. 125

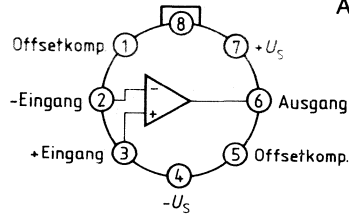

222, 222 S 1 Einfach OP

Abb. 122

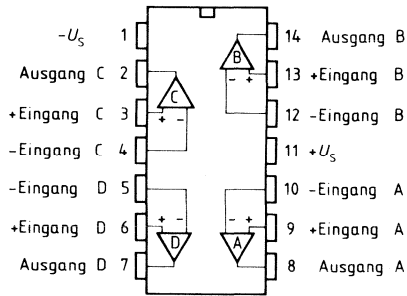

4332 A, 4335 A OP m. Darl.-Eing.

Abb. 126

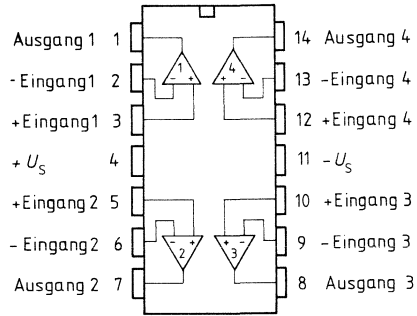

4453 A Vierfach-PNP-OP O.K.

Abb. 123

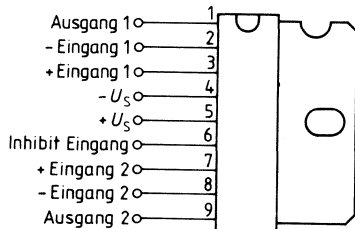

2365 Leistungs-OP

Frequenzkompensation

Abb. 127

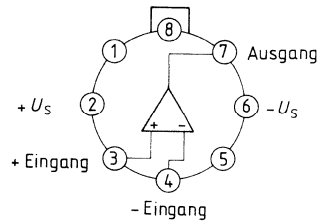

761, 762, 765 Operationsverst.

Abb. 124

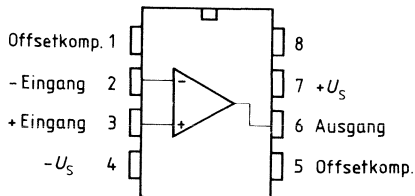

221 B, 222 B OP

Abb. 128

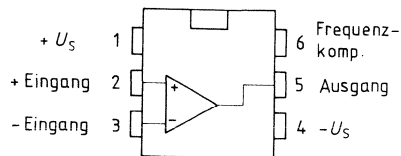

761 A, 765 A Operationsverst.

Linearschaltungen

Abb. 129

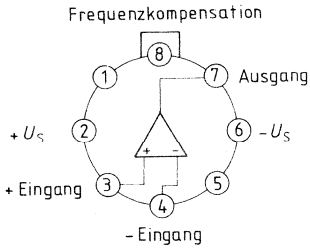

861, 862, 865 OP

Abb. 133

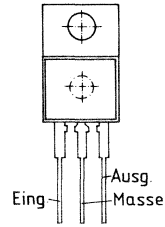

78 XX Spannungsreg.] > 1 A, max. 15 W

Abb. 130

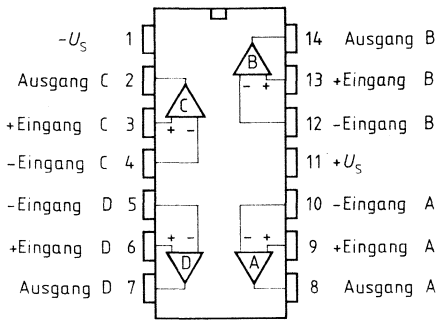

4331 A, 4335 A OP m. Darl.

Abb. 134

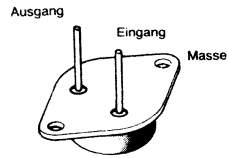

78 XX Spannungsreg. Geh. TO-3

Abb. 131

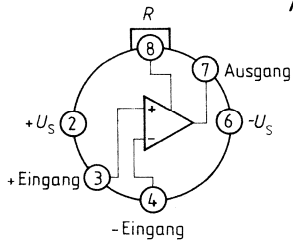

321, 322, 325 OP-TTL kompatibel.

(TOP VIEW)

Abb. 135

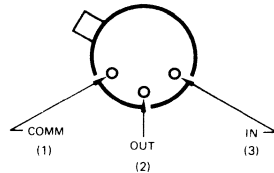

79 M XX Negativ-Spannungsreg.

Abb. 132

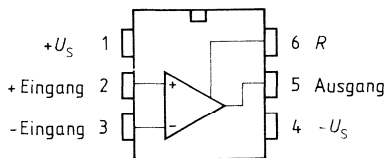

321, 325 A OP-TTL kompatibel.

Abb. 136

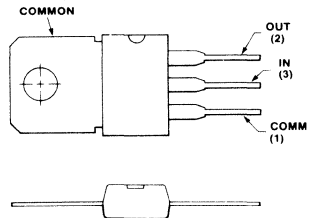

79 M XX Negativ 0,5 A TO-202

Linearschaltungen

Abb. 137

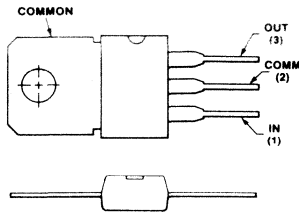

78 M XX Positiv-Spannungsreg. 0,5 A

Abb. 141

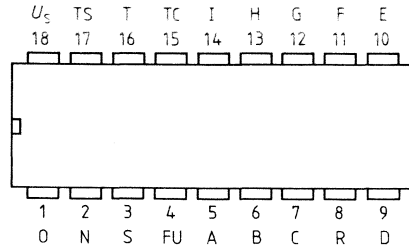

0 529 Programmierb. Dig.-Timer

Abb. 138

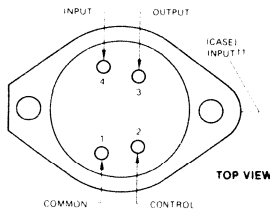

**-30 V TO -2.2 V
ADJUSTABLE REGULATOR**

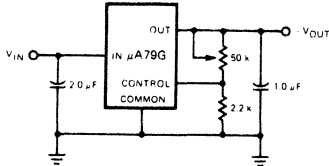

79 GKC, GKM -2,2 bis -30 V

Abb. 142

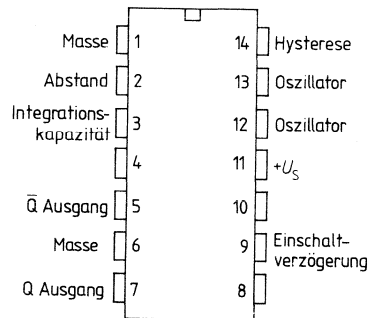

205 A Näherungsschalter

Abb. 139

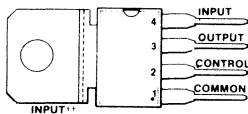

79 GK 1 C -2,2 bis -30 V

Abb. 143

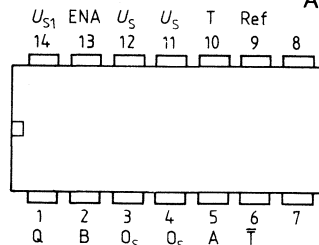

S 89 Einstellb. Teiler f. 500 MHz

Abb. 140

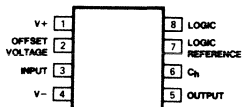

198, 298, 398, F, N

Abb. 144

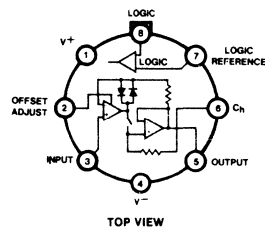

198, 298, 398, H

Linearschaltungen

Abb. 145

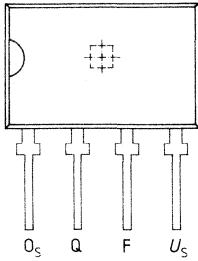

SAS 261 Kontakt-Sch.

Abb. 149

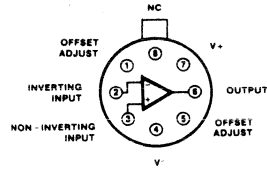
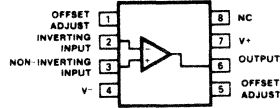

530, 538 Operations-Verst.

Abb. 146

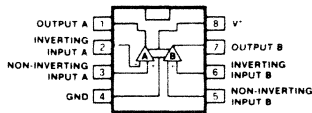

193, 293, 2903 Dual Sp. Comp.

Abb. 150

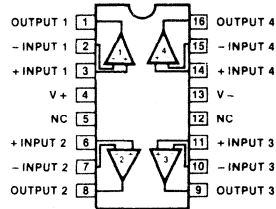

5514 F, N, D Vierfach OP

Abb. 147

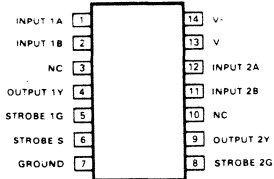

521, 22 High Speed Dual Comp.

Abb. 151

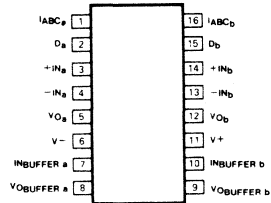

5517 Zweifach-OP

Abb. 148

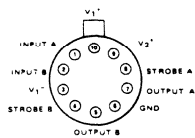
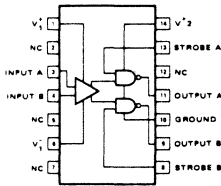

527, 529 Spannungs-Komparator

Abb. 152

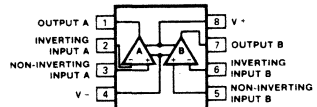

5532 Zweifach-OP - rauscharm

Abb. 153

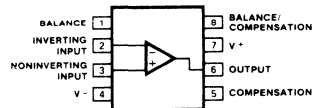

5534 Einfach-OP - rauscharm

Linearschaltungen

Abb. 154

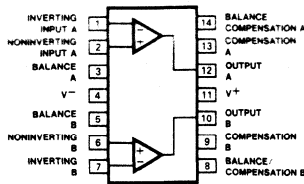

5533 Zweifach-OP, rauscharm

Abb. 160

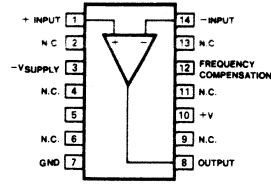

5539, F, N, D HF-OP

Abb. 155

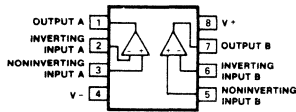

5535 N Dual-OP

Abb. 161

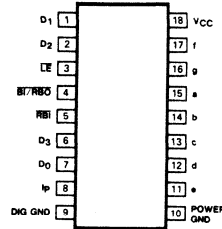

587 LED-Decoder/Treiber

Abb. 156

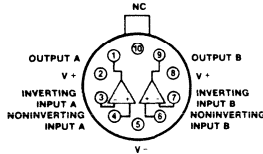

5535 H Dual-OP

Abb. 162

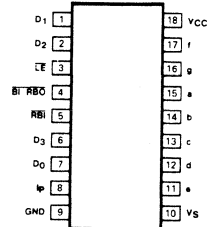

589 LED-Decoder/Treiber

Abb. 157

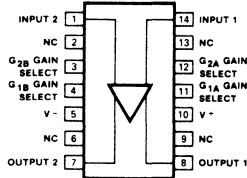

592 DH, FH, N 14 Video-Verst.

Abb. 163

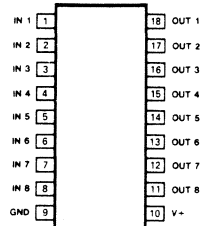

594 Fluoreszenz-Display-Treiber

Abb. 158

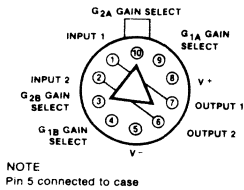

592 H Video-Verst.

Abb. 164

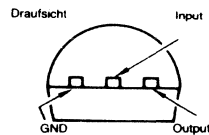

97 LXX Spannungsr. negativ 0,1 A

Abb. 159

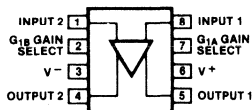

592 DE, FE Video-Verst.

Linearschaltungen

Abb. 165

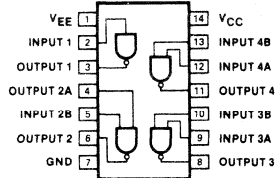

1488 Vierfach-Treiber

Abb. 166

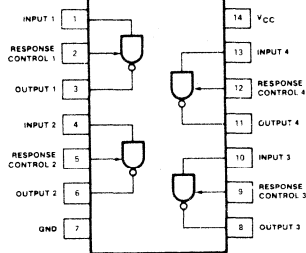

1489 Quad Line-Receiver

Abb. 167

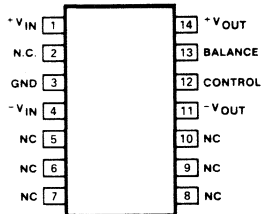

5553 F, N Dual-Spannungsr.

Abb. 168

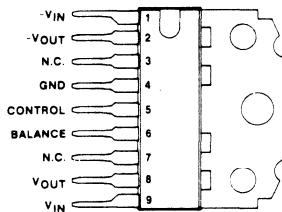

5553 U Dual-Spannungsr.

Abb. 169

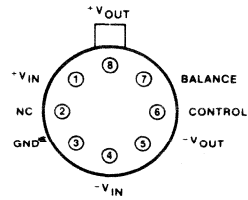

5553 H Dual-Spannungsr.

Abb. 170

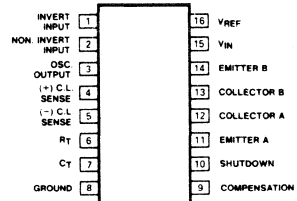

3524 Pulsweiten-Modul.

Abb. 171

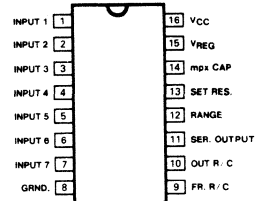

5044 Progr. 7-Kan.-RC-Encoder

Abb. 172

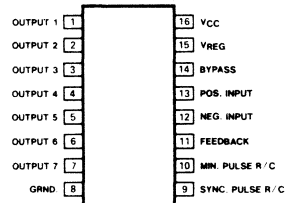

5045 7-Kan.-RC-Decoder

Abb. 173

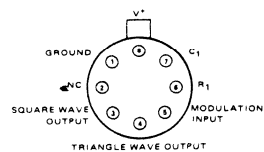

566 H Funktions-Gen.

Linearschaltungen

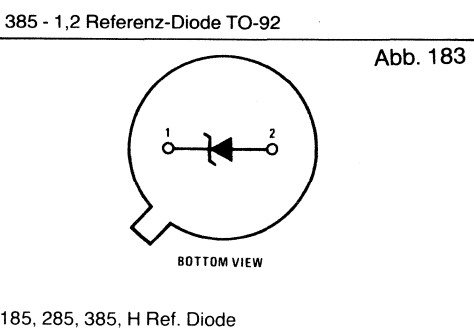
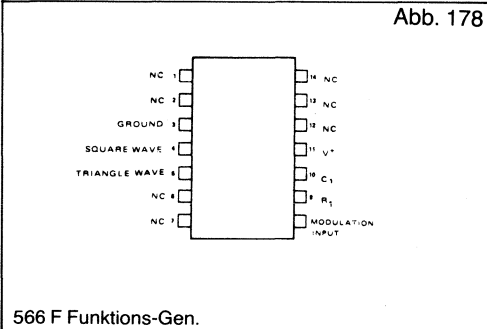
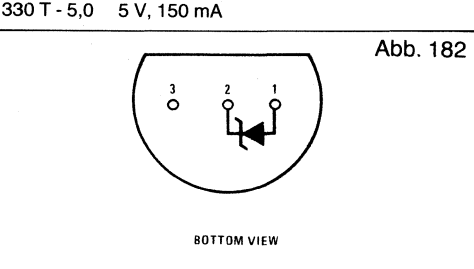
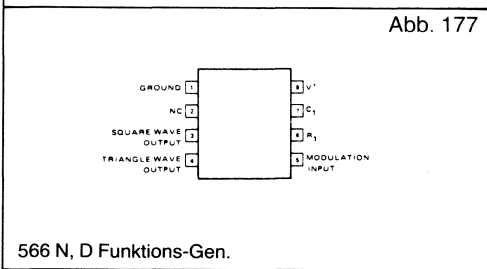
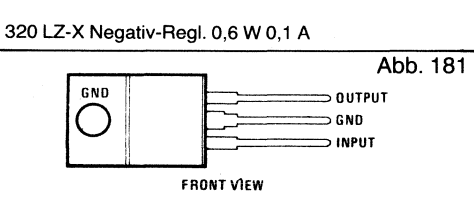
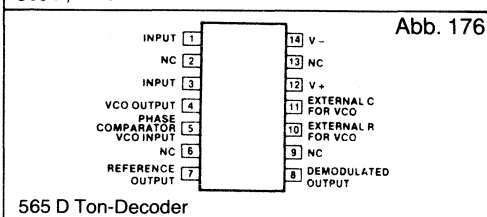
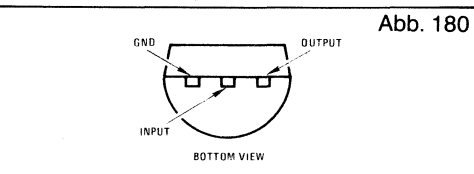
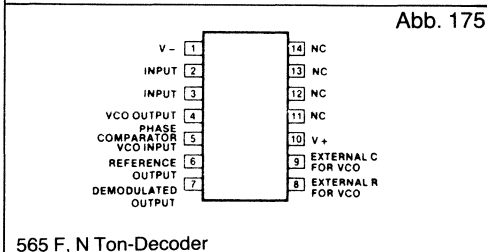
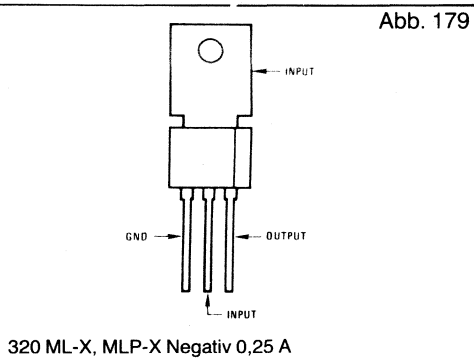
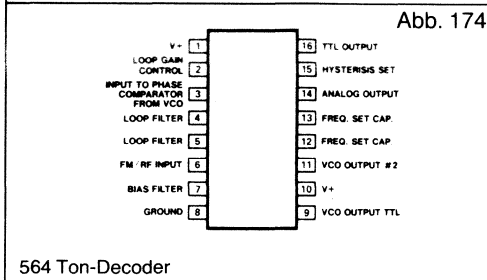

Linearschaltungen



Abb. 184

3026, 3049 Differential-Verst.



Abb. 188

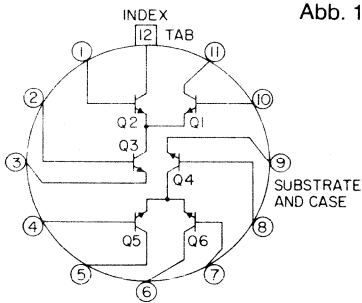

78 H GKC Spannungsreg. 5 - 24 V, 5 A

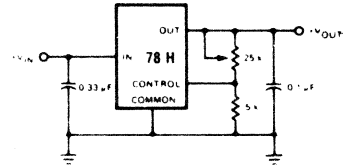
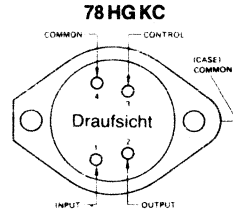

Abb. 185

3054 Differential-Verst.

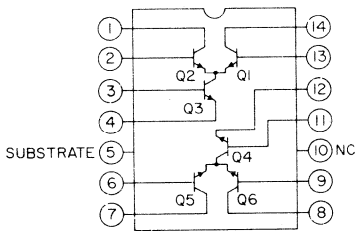

Abb. 189

78 LXX Spannungsreg. 0,1 A

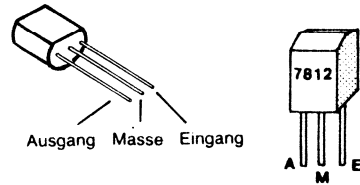

Abb. 186

3048, 3052 Verstärker

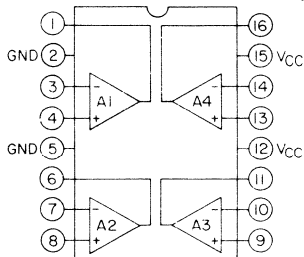

Abb. 190

79 XX Spannungsreg.

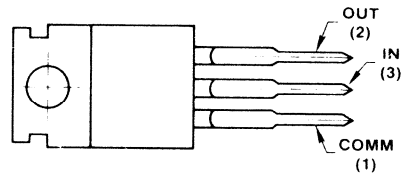

Abb. 187

3060 A, B OP-Verstärker

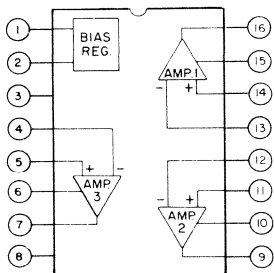

Abb. 191

711 Dual-Komparator

Quellennachweis

Als Quellen in diesem Buch dienten Datenbücher folgender Firmen:

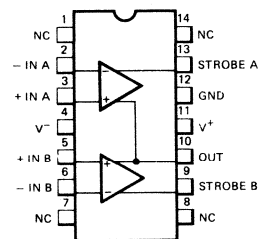
AEG - Telefunken
Exar
Fairchild
Intersil
Monsanto
RCA
Siemens
Thomsen
Texas Instruments
Valvo